



**Crafting Glow  
Since 1985**



**Product  
Catalogue  
2024**

**NSL**  
NATIONAL SPECIALTY LIGHTING  
YOUR TRUSTED LIGHTING PARTNER

📍 2299 Kenmore Avenue Tonawanda, New York 14207

☎ 303.926.1100 ✉ [nslsales@nslusa.com](mailto:nslsales@nslusa.com) 🌐 [www.nslusa.com](http://www.nslusa.com)

**NSL**  
NATIONAL SPECIALTY LIGHTING

# Product Categories at a Glance

## Linear Lighting

- Tape Light
- 120V eStrip
- eStrip
- Neon Flex
- String Lights
- Wall Washer

## Under Cabinet Lighting

## Landscape Lighting

- Flood and Spot Lights
- Pathway Lights
- Wall and Deck Lights
- In Ground Lights
- Transformers and Accessories

## Down Lighting

- Thin Lines
- Regressed
- Gimbal
- Surface Mount / Decorative
- T-Edge Lights
- Fire Rated

## Industrial Lighting

## Drivers and Controllers

Looking for something specific? Check out the [Appendix](#) for an in-depth breakdown of what each category contains and where to locate those items.

# Why NSL?

**At National Specialty Lighting (NSL), we've built a foundation of trust and innovation over the past 38 years, dedicated to illuminating spaces with state-of-the-art lighting technology.**

## Here's how we make a difference:

- **Your Needs First:** Our product catalog has grown over the years to better cater to your diverse lighting requirements, ensuring you always find what you need.
- **Unmatched Value:** We pride ourselves on offering competitive prices without compromising quality, providing exceptional value for your investment.
- **Peace of Mind:** Our products are backed by substantial warranty support, giving you a seamless and worry-free lighting experience.
- **Custom Displays:** With a variety of POP display options, we make it easy for you to highlight your lighting selections effectively.



# Linear Lighting

# High Density, High Power Indoor



Ideal for display cabinets needing high illumination. Can be used as a wall grazer offering great vertical illumination.

## HIGH DENSITY SINGLE COLOUR LTP-HD SERIES

### FEATURES

- 1 Bin
- 2 Step MacAdam Ellipse
- 3oz PCB board
- 3M Adhesive
- 50,000 hours life
- High brightness 3528 Epistar LEDs
- Field cuttable
- Low power consumption
- Available in 16' (5m) and 100' (30.48m) spools (custom cuts available)
- 16' spools come with 6Ft pre-soldered power feeds
- Safe, 24V class 2 power supplies (sold separately)
- Fully dimmable with dimmable power supplies (sold separately)
- 6 years limited warranty

### APPLICATIONS

- Aisle and stairway lighting
- Cabinet and cove lighting
- Back lighting
- Showcase lighting
- Linear decorative lighting

### SPECIFICATIONS

<b>Product Code</b>		LTP-XX-YY-HD-H90
<b>Electrical</b>	<b>Input Voltage</b>	24V DC
	<b>Power Consumption</b>	5.8W/Ft
<b>Specs</b>	<b>Colour Temperature</b>	2700/3000/4000/6500K
	<b>CRI</b>	90+
	<b>Lumen Output</b>	450 Lumens per ft 3000K; 468 Lumens per ft 4000K; 514 Lumens per ft 6500K
	<b>Efficacy</b>	77 LPW 3000K; 80 LPW 4000K; 88 LPW 6500K
	<b>Dimmable</b>	Yes
	<b>Beam Angle</b>	120°
<b>LED</b>	<b>Type</b>	High Brightness 3528 Epistar LEDs
	<b>Life Span</b>	50,000 Hours
	<b>Spacing</b>	1" (25mm)
	<b># per foot (304mm)</b>	72
<b>Design</b>	<b>Dimensions (Inches)</b>	.39" W
	<b>Dimensions (Millimeters)</b>	10mm W
	<b>Max Single Run Length</b>	16Ft
	<b>Custom Cuttable</b>	1" (25mm)
	<b>Approved Location</b>	Indoor
<b>Warranty</b>	6 years	
<b>Approvals</b>	cETLus	

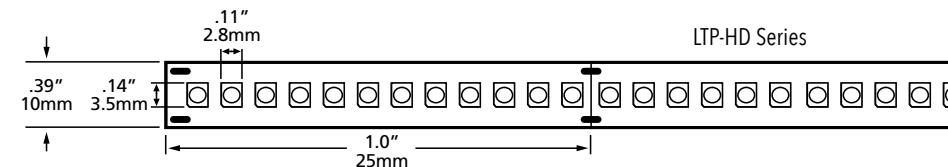

### PRODUCT CODES

16Ft spools  
LTP - 16 - YY - HD - H90

**LED COLOUR**  
2700K  
3000K  
4000K  
6500K

100Ft spools  
LTP - 100 - YY - HD - H90

**LED COLOUR**  
2700K  
3000K  
4000K  
6500K

Custom cuts  
LTP - XX - YY - HD - H90

**LED COLOUR**  
2700K  
3000K  
4000K  
6500K

### ACCESSORIES



**LTP-001-HD-HP-6**  
72" Power feed connector for high density indoor



**LMSII-001**  
Terminal block and junction box for connection to additional lengths of power cable if needed



**LTP-010-S**  
Clear PVC mounting "U" channel



**LV-SPIR-1CH-LV**  
PIR Motion Sensor, 1 Channel, 24V DC  
NOTE: To be used with non dimmable drivers only

NOTE: See page 35-36 for the complete range of aluminum extrusions.

### INDOOR/OUTDOOR DIMMABLE DRIVERS

#### TRE24L40DC

Max recommended load 36W or 6' LED Strip, min 8W or 2' LED Strip  
6.77" x 2.67" x 1.26" (171 x 68 x 32mm)

#### TRE24L96DC

Max recommended load 90W or 16' LED Strip, min 8W or 2' LED Strip  
6.77" x 2.67" x 1.26" (171 x 68 x 32mm)

### NON DIMMABLE DRIVERS

#### LEDDR-24-120W

Indoor/Outdoor driver  
Max. recommended load 90W or 20' (6.1m) per single tap, 120W or 27' (8.23m) combined two secondary taps.  
120W hardwire  
Input: 100 - 240V AC  
Output: 24V DC  
10" x 3 3/8" x 3 3/16" (254 x 85.7 x 80.9mm)

# High Density, Low Power Indoor



Suitable for display cabinets and applications needing lower but even illumination.

## HIGH DENSITY SINGLE COLOUR LTP-HD-LP SERIES

### FEATURES

- 1 Bin
- 2 Step MacAdam Ellipse
- 3oz PCB board
- 3M Adhesive
- 50,000 hours life
- High brightness 5060 SMD LEDs
- Field cuttable
- Low power consumption
- Available in 20' (6.1m) and 100' (30.48m) spools (custom cuts available)
- Safe, 24V class 2 power supplies (sold separately)
- Fully dimmable with dimmable power supplies (sold separately)
- 20' spools come with 6 ft. pre-soldered power feeds
- 6 year limited warranty

### APPLICATIONS

- Aisle and stairway lighting
- Cabinet and cove lighting
- Back lighting
- Showcase lighting
- Linear decorative lighting

### SPECIFICATIONS

<b>Product Code</b>		LTP-XX-YY-HD-LP-H90
<b>Electrical</b>	<b>Input Voltage</b>	24V DC
	<b>Power Consumption</b>	2.9W/Ft
<b>Specs</b>	<b>Colour Temperature</b>	2700/3000/4000/6500K
	<b>CRI</b>	90
	<b>Lumen Output</b>	225 Lumens per ft 3000K; 234 Lumens per ft 4000K; 257 Lumens per ft 6500K
	<b>Efficacy</b>	77 LPW 3000K; 80 LPW 4000K; 88 LPW 6500K
	<b>Dimmable</b>	Yes
	<b>Beam Angle</b>	120°
<b>LED</b>	<b>Type</b>	High Brightness 3528 Epistar LEDs
	<b>Life Span</b>	50,000 Hours
	<b>Spacing</b>	8.3mm
	<b># per foot (304mm)</b>	36
<b>Design</b>	<b>Dimensions (Inches)</b>	31" W
	<b>Dimensions (Millimeters)</b>	0 8mm W
	<b>Max Single Run Length</b>	31Ft
	<b>Custom Cuttable</b>	2" (50mm)
	<b>Approved Location</b>	Indoor
<b>Warranty</b>	6 years	
<b>Approvals</b>	cETLus	

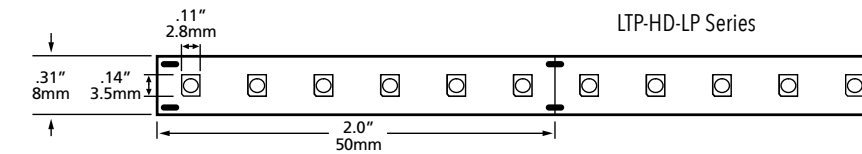

### PRODUCT CODES

16Ft spools  
LTP - 16 - YY - HD - LP - H90

100Ft spools  
LTP - 100 - YY - HD - LP - H90

Custom cuts  
LTP - XX - YY - HD - LP - H90

**LED COLOUR**  
2700K  
3000K  
4000K  
6500K

**LED COLOUR**  
2700K  
3000K  
4000K  
6500K

**LED COLOUR**  
2700K  
3000K  
4000K  
6500K

### ACCESSORIES



**LTP-001-HD-6**  
72" Power feed connector for high density indoor

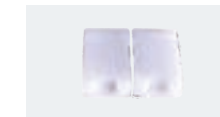

**LTP-002-HD**  
In-line connector for high density indoor



**LTP-STP-HD-6IN**  
6" In-line connector for high density indoor



**LMSII-001**  
Terminal block and junction box for connection to additional lengths of power cable if needed



**LTP-010-S**  
Clear PVC mounting "U" channel



**LV-SPIR-1CH-LV**  
PIR Motion Sensor, 1 Channel, 24V DC  
NOTE: To be used with non dimmable drivers only

NOTE: See page 35-36 for the complete range of aluminum extrusions.

### INDOOR/OUTDOOR DIMMABLE DRIVERS

**TRE24L40DC**  
Max recommended load 36W or 12' LED Tape, min 8W or 3' LED Tape  
6.77" x 2.67" x 1.26" (171 x 68 x 32mm)

**TRE24L96DC**  
Max recommended load 90W or 31' LED Tape, min 8W or 3' LED Tape  
6.77" x 2.67" x 1.26" (171 x 68 x 32mm)

### NON DIMMABLE DRIVERS

**LEDDR-24-120W**  
Indoor/Outdoor driver  
Max. recommended load 90W or 31' (9.4m) per single tap, 120W or 41' (12.5m) combined two secondary taps.  
120W hardwire  
Input: 100 - 240V AC  
Output: 24V DC  
10" x 3 3/8" x 3 3/16" (254 x 85.7 x 80.9mm)

# CCT Indoor

Where applications demand a greater dynamic range within the White Light Spectrum. Hospitality, retail, residential and commercial.



## CCT COLOUR TEMP ADJUST SERIES

### FEATURES

- 50,000 hours life
- High brightness 3528 SMD LEDs
- Field cuttable
- Low power consumption
- Available in 16' (5M) spools
- 16' spools come with 6 ft. pre-soldered power feeds
- Safe, 24V class 2 power supplies (sold separately)
- Controller sold separately
- 6 year limited warranty

### APPLICATIONS

- Aisle and stairway lighting
- Cabinet and cove lighting
- Back lighting
- Showcase lighting
- Linear decorative lighting

### SPECIFICATIONS

<b>Product Code</b>		LTP-16-CCT-H90
<b>Electrical</b>	Input Voltage	24V DC
	Power Consumption	5.8W/Ft
<b>Specs</b>	Colour Temperature	2500K-7000K
	CRI	>80
	Lumen Output	261 Lumens per ft 3000K; 383 Lumens per ft 7000K
	Efficacy	77 LPW 3000K, 80 LPW 4000K, 88 LPW 6500K
	Dimmable	No
	Beam Angle	120°
<b>LED</b>	Type	High Brightness 3528 SMD LEDs
	Life Span	50,000 Hours
	Spacing	8.3mm
	# per foot (304mm)	36
<b>Design</b>	Dimensions (Inches)	.39" W
	Dimensions (Millimeters)	10mm W
	Max Single Run Length	16Ft
	Custom Cuttable	2" (50mm)
	Approved Location	Indoor
<b>Warranty</b>	6 years	
<b>Approvals</b>	cETLus	

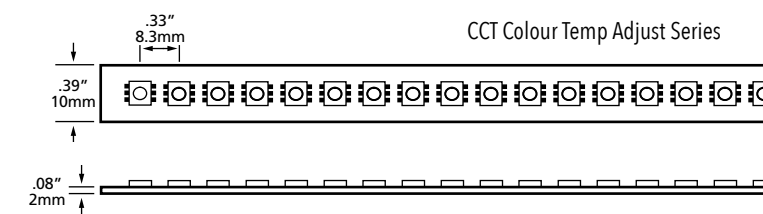

### PRODUCT CODES

16Ft spools  
LTP - 16 - CCT - H90

### ACCESSORIES



**LTP-001-HD-6**  
72" Power feed connector for high density indoor

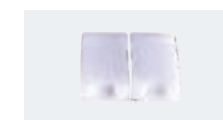

**LTP-002-CCT**  
In-line connector for CCT series indoor



**LV-CN-J10-CCT**  
6" (15cm) in line connector



**LTP-010-S**  
Clear PVC mounting "U" channel



**LT-WIFI-AMP**  
WiFi Signal Amplifier for RGB, RGBW, CCT

**NOTE:** See page 35-36 for the complete range of aluminum extrusions.

### NON DIMMABLE DRIVERS

#### LEDDR-24-120W

Indoor/Outdoor driver  
16' (4.88m) per single tap, 20' (6.1m) combined two secondary taps. 120W hardwire  
Input: 100 - 240V AC  
Output: 24V DC  
10" x 3 3/8" x 3 3/16" (254 x 85.7 x 80.9mm)

# COB Indoor

The COB indoor lights are designed for optimal performance, delivering uniform lighting ideal for a variety of settings including commercial spaces, retail environments, and homes.



## FEATURES

- 1 Bin
- 2 Step MacAdam Ellipse
- 3oz PCB board
- 3M Adhesive
- Field cuttable every 50mm (2")
- Low power consumption
- Smooth luminance - no hot spots
- Available in 20' (6.1m) and 100' (30.48m) spools (custom cuts available)
- 20' spools come with 6Ft pre-soldered power feeds
- Safe, 24V DC operation
- Fully dimmable with dimmable power supplies (sold separately)
- 6 years limited warranty

## APPLICATIONS

- Aisle and stairway lighting
- Cabinet and cove lighting
- Back lighting
- Showcase lighting
- Linear decorative lighting

SPECIFICATIONS		
<b>Product Code</b>	LTP-XX-YY-COB-H90	
<b>Electrical</b>	Input Voltage	24V DC
	Power Consumption	4.2W/Ft
<b>Specs</b>	Colour Temperature	2700/3000/3500/4000/6500K
	CRI	90
	Lumen Output	315 Lumens per ft 2700K; 319 Lumens per ft 3000K; 328 Lumens per ft 3500K; 336 Lumens per ft 4000K; 374 Lumens per ft 6500K
	Efficacy	75 LPW 2700K; 76 LPW 3000K; 78 LPW 3500K; 80 LPW 4000K; 89 PLW 6500K
	Dimmable	Yes
	Beam Angle	120°
<b>LED</b>	Type	High Brightness LEDs
	Life Span	50,000 Hours
	Spacing	2mm
	# per foot (304mm)	91
<b>Design</b>	Dimensions (Inches)	.39" W
	Dimensions (Millimeters)	10mm W
	Max Single Run Length	20Ft
	Custom Cuttable	2" (50mm)
	Approved Location	Indoor
<b>Warranty</b>	6 years	
<b>Approvals</b>	cETLus	

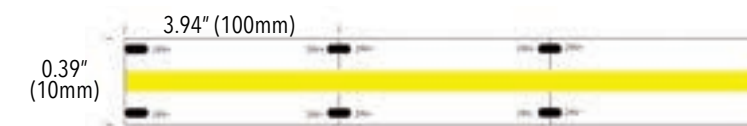

## PRODUCT CODES

20Ft spools  
LTP - 20 - YY - COB - H90

LED TAPE LIGHT  
COB, Indoor

LED COLOUR  
2700K  
3000K  
3500K  
4000K  
6500K

100Ft spools  
LTP - 100 - YY - COB - H90

LED TAPE LIGHT  
COB, Indoor

LED COLOUR  
2700K  
3000K  
3500K  
4000K  
6500K

Custom cuts  
LTP - XX - YY - COB - H90

LED TAPE LIGHT  
COB, Indoor

LED COLOUR  
2700K  
3000K  
3500K  
4000K  
6500K

LTP - 20 - YY - COB

LED TAPE LIGHT  
COB, Indoor

LED COLOUR  
RD: Red  
AM: Amber  
GR: Green  
BL: Blue

LTP - 100 - YY - COB

LED TAPE LIGHT  
COB, Indoor

LED COLOUR  
RD: Red  
AM: Amber  
GR: Green  
BL: Blue

LTP - XX - YY - COB

LED TAPE LIGHT  
COB, Indoor

LED COLOUR  
RD: Red  
AM: Amber  
GR: Green  
BL: Blue

## ACCESSORIES



**LTP-001-HD-HP-6**  
72" Power feed connector for CCT indoor. Add "-O" for opposite end.



**LMSII-001**  
Terminal block and junction box for connection to additional lengths of power cable if needed



**LTP-010-S**  
Clear PVC mounting "U" channel



**LV-SPIR-1CH-LV**  
PIR Motion Sensor, 1 Channel, 24V DC  
NOTE: To be used with non dimmable drivers only

NOTE: See page 35-36 for the complete range of aluminum extrusions.

## INDOOR/OUTDOOR DIMMABLE DRIVERS

**TRE24L40DC**  
Max 8.6' (2.6m)  
Min 8 Watts, 1.9'(0.57M) LED COB Strip  
6.77" x 2.67" x 1.26" (171 x 68 x 32mm)

**TRE24L96DC**  
Max 21.4' (6.5m)  
Min 8 Watts, 1.9'(0.57m) LED COB Strip  
6.77" x 2.67" x 1.26" (171 x 68 x 32mm)

## NON DIMMABLE DRIVERS

**LEDDR-24-120W**  
Indoor/Outdoor driver  
Max 21.4' (6.5m) per single tap  
Max 28' (8.5m) combined 2 secondary taps  
Input: 100 - 240V AC  
Output: 24V DC  
10" x 3 3/8" x 3 3/16" (254 x 85.7 x 80.9mm)

# Dim to Warm

Suitable for both hospitality and residential applications creating an inviting atmosphere.



## FEATURES

- 1 Bin
- 2 Step MacAdam Ellipse
- 3oz PCB board
- 3M Adhesive
- 50,000 hours life
- Field cuttable every 50mm (2")
- Low power consumption
- Auto Warm-dim technology
- Available in 16' (5m) and 100' (30.48m) spools (custom cuts available)
- 16' spools come with 6Ft pre-soldered power feeds
- Safe, 24V DC operation
- Dim-to-warm: 1800k to 3000K
- No special controllers required
- 6 years limited warranty

## APPLICATIONS

- Aisle and stairway lighting
- Cabinet and cove lighting
- Back lighting
- Showcase lighting
- Linear decorative lighting

## SPECIFICATIONS

<b>Product Code</b>		LTP-XX-WW-DIM-H90
<b>Electrical</b>	<b>Input Voltage</b>	24V DC
	<b>Power Consumption</b>	5.5W/Ft
<b>Specs</b>	<b>Colour Temperature</b>	1800-3000K
	<b>CRI</b>	90
	<b>Lumen Output</b>	449LM/Ft
	<b>Efficacy</b>	N/A
	<b>Dimmable</b>	Yes
	<b>Beam Angle</b>	120°
<b>LED</b>	<b>Type</b>	Epistar
	<b>Life Span</b>	50,000 Hours
	<b>Spacing</b>	2mm
	<b># per foot (304mm)</b>	240
<b>Design</b>	<b>Dimensions (Inches)</b>	.39" W
	<b>Dimensions (Millimeters)</b>	10mm W
	<b>Max Single Run Length</b>	16Ft
	<b>Custom Cuttable</b>	2" (50mm)
	<b>Approved Location</b>	Indoor
<b>Warranty</b>	6 years	
<b>Approvals</b>	cETLus	

## PRODUCT CODES

- 16Ft spools**  
LTP - 16 - WW - DIM - H90
- 100Ft spools**  
LTP - 100 - WW - DIM - H90
- Custom cuts**  
LTP - XX - WW - DIM - H90

## ACCESSORIES



**LTP-001-HD-HP-6**  
72" Power feed connector for high density indoor



**LMSII-001**  
Terminal block and junction box for connection to additional lengths of power cable if needed

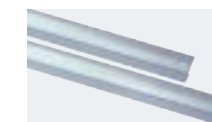

**LTP-010-S**  
Clear PVC mounting "U" channel

NOTE: See page 35-36 for the complete range of aluminum extrusions.

## INDOOR/OUTDOOR DIMMABLE DRIVERS

**TRE24L40DC**  
Max 6.5' (1.98m)  
Min 8 Watts, 1.45' (0.44m)  
6.77" x 2.67" x 1.26" (171 x 68 x 32mm)

**TRE24L96DC**  
Max 16' (5m)  
Min 8 Watts, 1.45' (0.44m)  
6.77" x 2.67" x 1.26" (171 x 68 x 32mm)



# High Efficacy Indoor

One of the highest lumen output solutions, for those applications needing high illumination and great color rendering.



## FEATURES

- 1 Bin
- 2 Step MacAdam Ellipse
- 3oz PCB board
- 3M Adhesive
- 50,000 hours life
- Field cuttable every 1.3"
- Low power consumption
- Available in 16' (5m) and 100' (30.48m) spools (custom cuts available)
- 16' spools come with 6Ft pre-soldered power feeds
- Safe, 24V DC operation
- Fully dimmable with dimmable power supplies (sold separately)
- 6 years limited warranty

## APPLICATIONS

- Aisle and stairway lighting
- Cabinet and cove lighting
- Back lighting
- Showcase lighting
- Linear decorative lighting

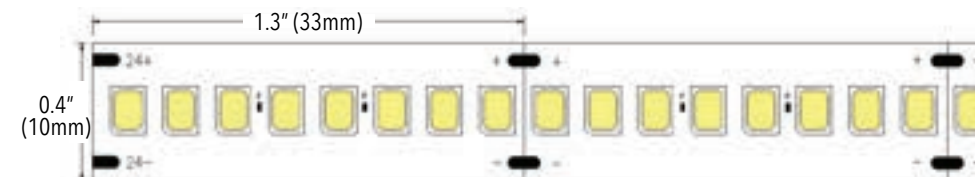

## PRODUCT CODES

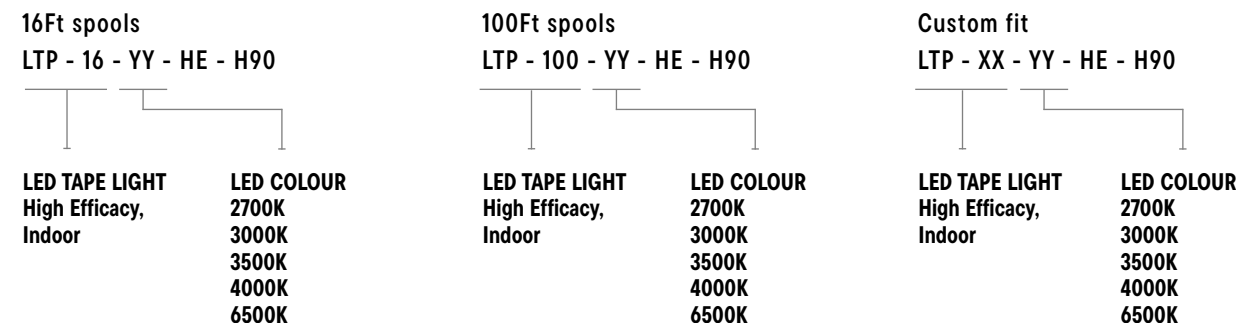

SPECIFICATIONS		
<b>Product Code</b>	LTP-XX-YY-HE-H90	
<b>Electrical</b>	Input Voltage	24V DC
	Power Consumption	5.1W/Ft
<b>Specs</b>	Colour Temperature	3000/4000/6500K
	CRI	90
	Lumen Output	508 Lumens per ft 2700K; 512 Lumens per ft 3000K; 527 Lumens per ft 3500K; 540 Lumens per ft 4000K; 586 Lumens per ft 6500K
	Efficacy	99 LPW 2700K; 100 LPW 3000K; 103 LPW 3500K; 80 LPW 4000K; 88 LPW 6500K
	Dimmable	Yes
	Beam Angle	120°
<b>LED</b>	Type	High Brightness 2835 LEDs
	Life Span	50,000 Hours
	Spacing	4mm
	# per foot (304mm)	73
<b>Design</b>	Dimensions (Inches)	.4" W
	Dimensions (Millimeters)	10mm W
	Max Single Run Length	16Ft
	Custom Cuttable	1.3" (33mm)
	Approved Location	Indoor
<b>Warranty</b>	6 years	
<b>Approvals</b>	cETLus	

## ACCESSORIES



**LTP-001-HD-HP-6**  
72" Power feed connector for high density indoor



**LMSII-001**  
Terminal block and junction box for connection to additional lengths of power cable if needed

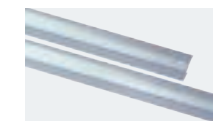

**LTP-010-S**  
Clear PVC mounting "U" channel



**LV-SPIR-1CH-LV**  
PIR Motion Sensor, 1 Channel, 24V DC  
NOTE: To be used with non dimmable drivers only

NOTE: See page 35-36 for the complete range of aluminum extrusions.

## INDOOR/OUTDOOR DIMMABLE DRIVERS

**TRE24L40DC**  
Max 7' (2.1m)  
Min 8 Watts, 1.5'(0.45M) LED High Efficacy Strip  
6.77" x 2.67" x 1.26" (171 x 68 x 32mm)

**TRE24L96DC**  
Max 17.6' (5.3m)  
Min 8 Watts, 1.5'(0.45m) LED High Efficacy Strip  
6.77" x 2.67" x 1.26" (171 x 68 x 32mm)

## NON DIMMABLE DRIVERS

**LEDDR-24-120W**  
Indoor/Outdoor driver  
Max 17.6' (5.3m) per single tap  
Max 23' (7m) combined 2 secondary taps  
Input: 100 - 240V AC  
Output: 24V DC  
10" x 3 3/8" x 3 3/16" (254 x 85.7 x 80.9mm)

# High Power Indoor

Suitable for high ceiling coves or areas that require higher illumination. Commercial, retail, hospitality and residential applications.



## HIGH POWER SINGLE COLOUR LTP-20 SERIES

### FEATURES

- 1 Bin
- 2 Step MacAdam Ellipse
- 3oz PCB board
- 3M Adhesive
- 50,000 hours life
- High brightness 5060 SMD LEDs
- Field cuttable
- Low power consumption
- Available in 20' (6.1m) and 100' (30.48m) spools (custom cuts available)
- Safe, 24V class 2 power supplies (sold separately)
- Fully dimmable with dimmable power supplies (sold separately)
- 20' spools come with 6 ft. pre-soldered power feeds
- 6 years limited warranty

### APPLICATIONS

- Aisle and stairway lighting
- Cabinet and cove lighting
- Back lighting
- Showcase lighting
- Linear decorative lighting

SPECIFICATIONS		
<b>Product Code</b>	LTP-XX-YY-H90	
<b>Electrical</b>	<b>Input Voltage</b>	24V DC
	<b>Power Consumption</b>	4.3W/Ft
<b>Specs</b>	<b>Colour Temperature</b>	2700/3000/3500/4000/6500K
	<b>CRI</b>	90+
	<b>Lumen Output</b>	280 Lumens per ft 2700K; 285 Lumens per ft 3000K; 293 Lumens per ft 3500K; 300 Lumens per ft 4000K; 325 Lumens per ft 6500K
	<b>Efficacy</b>	65 LPW 2700K; 66 LPW 3000K; 68 LPW 3500K; 70 LPW 4000K; 75 LPW 6500K
	<b>Dimmable</b>	Yes
	<b>Beam Angle</b>	120°
<b>LED</b>	<b>Type</b>	High Brightness 5060 SMD LEDs
	<b>Life Span</b>	50,000 Hours
	<b>Spacing</b>	16mm
	<b># per foot (304mm)</b>	18
<b>Design</b>	<b>Dimensions (Inches)</b>	.39" W
	<b>Dimensions (Millimeters)</b>	10mm W
	<b>Max Single Run Length</b>	20Ft
	<b>Custom Cuttable</b>	1.3" (33mm)
	<b>Approved Location</b>	Indoor
<b>Warranty</b>	6 years	
<b>Approvals</b>	cETLus	

### PRODUCT CODES

20Ft spools  
LTP - 20 - YY - H90

100Ft spools  
LTP - 100 - YY - H90

Custom cuts  
LTP - XX - YY - H90

**LED COLOUR**  
2700K  
3000K  
3500K  
4000K  
6500K

**LED COLOUR**  
2700K  
3000K  
3500K  
4000K  
6500K

**LED COLOUR**  
2700K  
3000K  
3500K  
4000K  
6500K

LTP - 20 - YY

LTP - 100 - YY

LTP - XX - YY

**LED COLOUR**  
RD: Red  
AM: Amber  
GR: Green  
BL: Blue

**LED COLOUR**  
RD: Red  
AM: Amber  
GR: Green  
BL: Blue

**LED COLOUR**  
RD: Red  
AM: Amber  
GR: Green  
BL: Blue

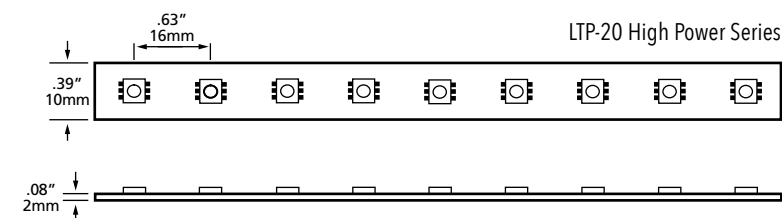

### DIMMABLE DRIVERS

#### TRE24L40DC

Max recommended load 36W or 8' LED Strip,  
min 8W or 2' LED Strip  
6.77" x 2.67" x 1.26" (171 x 68 x 32mm)

#### TRE24L96DC

Max recommended load 90W or 20' LED Strip,  
min 8W or 2' LED Strip  
6.77" x 2.67" x 1.26" (171 x 68 x 32mm)

### NON DIMMABLE DRIVERS

#### LEDDR-24-120W

Indoor/Outdoor driver  
Max. recommended load 90W or 20' (6.1m) per single tap,  
120W or 27' (8.23m) combined two secondary taps.  
120W hardwire  
Input: 100 - 240V AC  
Output: 24V DC  
10" x 3 3/8" x 3 3/16" (254 x 85.7 x 80.9mm)

### ACCESSORIES



**LTP-001-6R**  
72" Power feed connector  
for high density indoor

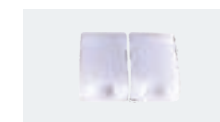

**LTP-002**  
In-line connector for CCT  
series indoor

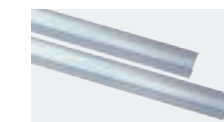

**LTP-010-S**  
Clear PVC mounting  
"U" channel



**LTP-003-6DC**  
DC connector for LED TAPE  
LIGHT with 6" wire and DC  
connector



**LTP-STP-6IN**  
5.9" (15cm)  
**LTP-STP-2IN**  
2" (5cm)  
**LTP-STP-2**  
2" (61cm)



**LMSII-001**  
Terminal block and junction  
box for connection to  
additional lengths of power  
cable if needed



**LV-SPIR-1CH-LV**  
PIR Motion Sensor, 1  
Channel, 24V DC  
NOTE: To be used with non  
dimmable drivers only

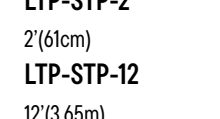

**LTP-STP-12**  
12" (3.65m)  
In-line connector for single  
colour indoor

**NOTE:** See page 35-36 for the complete range of  
aluminum extrusions.

# High Power Outdoor

Exterior rated suitable for those commercial, retail and hospitality applications requiring higher illumination.



## HIGH POWER SINGLE COLOUR LTP-OD SERIES

### FEATURES

- 1 Bin
- 2 Step MacAdam Ellipse
- 3oz PCB board
- 3M Adhesive
- 50,000 hours life
- High brightness 5060 SMD LEDs
- Field cuttable
- Low power consumption
- Available in 20' (6.1m) spools
- Safe, 24V class 2 power supplies (sold separately)
- Fully dimmable with dimmable power supplies (sold separately)
- 6 years limited warranty

### APPLICATIONS

- Aisle and stairway lighting
- Cabinet and cove lighting
- Back lighting
- Showcase lighting
- Linear decorative lighting

SPECIFICATIONS		
<b>Product Code</b>	LTP-OD-20-YY-H90	
<b>Electrical</b>	<b>Input Voltage</b>	24V DC
	<b>Power Consumption</b>	4.3W/Ft
<b>Specs</b>	<b>Colour Temperature</b>	2700/3000/3500/4000/6500K
	<b>CRI</b>	90+
	<b>Lumen Output</b>	280 Lumens per ft 2700K; 285 Lumens per ft 3000K; 293 Lumens per ft 3500K; 300 Lumens per ft 4000K; 325 Lumens per ft 6500K
	<b>Efficacy</b>	65 LPW 2700K; 66 LPW 3000K; 68 LPW 3500K; 70 LPW 4000K; 75 LPW 6500K
	<b>Dimmable</b>	Yes
	<b>Beam Angle</b>	120°
<b>LED</b>	<b>Type</b>	High Brightness 5060 SMD LEDs
	<b>Life Span</b>	50,000 Hours
	<b>Spacing</b>	16mm
	<b># per foot (304mm)</b>	18
<b>Design</b>	<b>Dimensions (Inches)</b>	.39" W
	<b>Dimensions (Millimeters)</b>	10mm W
	<b>Max Single Run Length</b>	20Ft
	<b>Custom Cuttable</b>	4"
	<b>Approved Location</b>	Outdoor
<b>Warranty</b>	6 years	
<b>Approvals</b>	cETLus	

NOTE: Outdoor TAPE LIGHT comes with liquid-tight connectors pre-installed on both ends, so it is necessary to make the cuts starting from extremities. Cut pieces can be terminated, but not joined together.

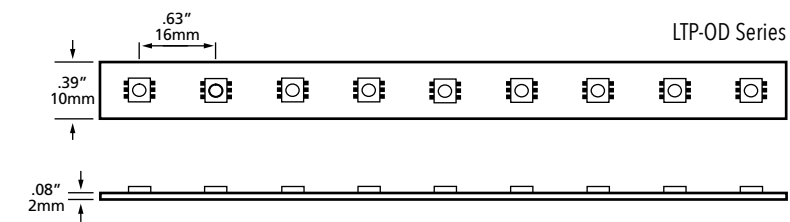

### PRODUCT CODES

LTP - OD - 20 - YY - H90

- LED COLOUR**  
 2700K  
 3000K  
 3500K  
 4000K  
 6500K

### ACCESSORIES



**LTP-001-OD-6FT**  
72" Power feed connector for single colour outdoor



**LV-FS-MC-004**  
Mounting clips



**LV-FS-EC-001**  
End caps

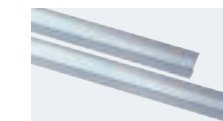

**LTP-010-S**  
Clear PVC mounting "U" channel

NOTE: See page 35-36 for the complete range of aluminum extrusions.

### INDOOR/OUTDOOR DIMMABLE DRIVERS

#### TRE24L40DC

Max recommended load 36W or 8' LED Tape, min 8W or 2' LED Tape  
 6.77" x 2.67" x 1.26" (171 x 68 x 32mm)

#### TRE24L96DC

Max recommended load 90W or 20' LED Tape, min 8W or 2' LED Tape  
 6.77" x 2.67" x 1.26" (171 x 68 x 32mm)

NOTE: For outdoor installations, please add E-KO-SR strain relief (2pcs/driver).

### NON DIMMABLE DRIVERS

#### LEDDR-24-120W

Indoor/Outdoor driver  
 Max. recommended load 90W or 20' (6.1m) per single tap, 120W or 27' (8.23m) combined two secondary taps.  
 120W hardwire  
 Input: 100 - 240V AC  
 Output: 24V DC  
 10" x 3 3/8" x 3 3/16" (254 x 85.7 x 80.9mm)

# High Power, RGB Indoor

Excellent choice for dynamic environments such as cinemas, retail and hospitality needing higher illumination.



## HIGH POWER RGB LTP-20-RGB SERIES

### FEATURES

- 50,000 hours life
- High brightness 5060 SMD LEDs
- Field cuttable
- Low power consumption
- Available in 20' (6.1m) and 100' (30.48m) spools (custom cuts available)
- 20' spools come with 6 ft. pre-soldered power feeds
- Safe, 24V class 2 power supplies (sold separately)
- Controllers sold separately
- 6 years limited warranty

### APPLICATIONS

- Aisle and stairway lighting
- Cabinet and cove lighting
- Back lighting
- Showcase lighting
- Linear decorative lighting

### SPECIFICATIONS

Product Code		LTP-XX-RGB
Electrical	Input Voltage	24V DC
	Power Consumption	4.3W/Ft
Specs	Colour Temperature	RGB
	Dimmable	Yes
	Beam Angle	120°
LED	Type	High Brightness 5060 SMD LEDs
	Life Span	50,000 Hours
	Spacing	16mm
	# per foot (304mm)	18
Design	Dimensions (Inches)	.39" W
	Dimensions (Millimeters)	10mm W
	Max Single Run Length	20Ft
	Custom Cuttable	4"
	Approved Location	Indoor
Warranty	6 years	
Approvals	cETLus	

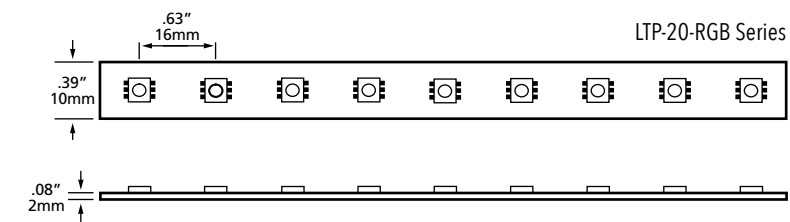

### PRODUCT CODES

- 20Ft spools  
LTP - 20 - RGB
- 100Ft spools  
LTP - 100 - RGB
- Custom cuts  
LTP - XX - RGB

### ACCESSORIES



**LTP-001-RGB-6R**  
72" Power feed connector for RGB indoor. Add "-O" for opposite end

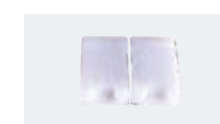

**LTP-002-RGB**  
In-line connector for RGB indoor

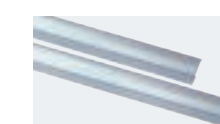

**LTP-010-S**  
Clear PVC mounting "U" channel



**LTP-001-RGB-6IN**  
6" In-line connector for RGB indoor



**LT-WIFI-RM**  
4-Zone RGB+CCT Remote



**LT-WIFI-CTRL**  
3 IN 1 LED Strip Controller (WiFi+2.4G)



**LT-WIFI-AMP**  
WiFi Signal Amplifier for RGB, RGBW, CCT

**LTP-001-RGB-2IN**  
2" In-line connector for RGB indoor

**NOTE:** See page 35-36 for the complete range of aluminum extrusions.

### NON DIMMABLE DRIVERS

**LEDDR-24-120W**  
Indoor/Outdoor driver  
Max. recommended load 90W or 20' (6.1m) per single tap, 120W or 27' (8.23m) combined two secondary taps.  
120W hardwire  
Input: 100 - 240V AC  
Output: 24V DC  
10" x 3 3/8" x 3 3/16" (254 x 85.7 x 80.9mm)

# High Power, RGB Outdoor



Great for enhancing outdoor spaces with a dynamic look. Suitable for hospitality, retail and commercial environments.

## HIGH POWER RGB OUTDOOR LTP-OD-RGB SERIES

### FEATURES

- 50,000 hours life
- High brightness 5060 SMD LEDs
- Field cuttable
- Low power consumption
- Available in 20' (6.1m) spools
- Safe, 24V class 2 power supplies (sold separately)
- 6 years limited warranty

### APPLICATIONS

- Aisle and stairway lighting
- Cabinet and cove lighting
- Back lighting
- Showcase lighting
- Linear decorative lighting

### SPECIFICATIONS

<b>Product Code</b>		LTP-OD-20-RGB
<b>Electrical</b>	Input Voltage	24V DC
	Power Consumption	4.3W/Ft
<b>Specs</b>	Colour Temperature	RGB
	CRI	80+
	Dimmable	Yes
	Beam Angle	120°
<b>LED</b>	Type	High Brightness 5060 SMD LEDs
	Life Span	50,000 Hours
	Spacing	16mm
	# per foot (304mm)	18
<b>Design</b>	Dimensions (Inches)	.39" W
	Dimensions (Millimeters)	10mm W
	Max Single Run Length	20Ft
	Custom Cuttable	4"
	Approved Location	Outdoor
<b>Warranty</b>	6 years	
<b>Approvals</b>	cETLus	

**NOTE:** Outdoor TAPE LIGHT comes with liquid-tight connectors pre-installed on both ends, so it is necessary to make the cuts starting from extremities. Cut pieces can be terminated, but not joined together.

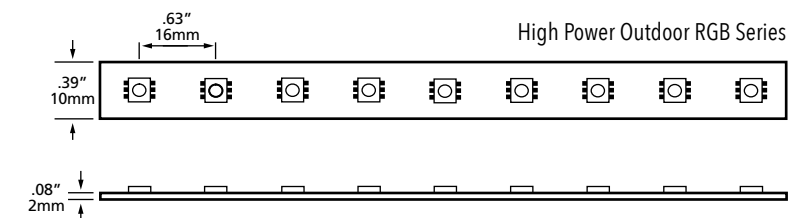

### PRODUCT CODES

20Ft spools  
LTP - OD - 20 - RGB

### ACCESSORIES



**LTP-RGB-001-OD-6FT**  
72" Power feed connector for RGB outdoor



**LV-FS-MC-004**  
Mounting clips



**LV-FS-EC-001**  
End caps

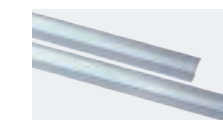

**LTP-010-S**  
Clear PVC mounting "U" channel



**LT-WIFI-RM**  
4-Zone RGB+CCT Remote



**LT-WIFI-CTRL**  
3 IN 1 LED Strip Controller (WiFi+2.4G)



**LT-WIFI-AMP**  
WiFi Signal Amplifier for RGB, RGBW, CCT

**NOTE:** See page 35-36 for the complete range of aluminum extrusions.

### NON DIMMABLE DRIVERS

#### LEDDR-24-120W

Indoor/Outdoor driver  
Max. recommended load 90W or 20' (6.1m) per single tap, 120W or 27' (8.23m) combined two secondary taps.  
120W hardwire  
Input: 100 - 240V AC  
Output: 24V DC  
10" x 3 3/8" x 3 3/16" (254 x 85.7 x 80.9mm)

# High Power, RGBW Indoor



Offers dynamic range of colour and dedicated white for greater versatility suitable for all market segments.

## HIGH POWER RGB LTP-20-RGBW SERIES

### FEATURES

- 50,000 hours life
- High brightness 5050 SMD LEDs
- Field cuttable
- Low power consumption
- Available in 20' (6.1m) and 100' (30.48m) spools (customcuts available)
- RGB colour change plus 3000K, 4000K and 6500K colour temperatures
- 20' spools come with 6 ft. pre-soldered power feeds
- Safe, 24V class 2 power supplies (sold separately)

### APPLICATIONS

- Aisle and stairway lighting
- Cabinet and cove lighting
- Back lighting
- Showcase lighting
- Linear decorative lighting

### SPECIFICATIONS

<b>Product Code</b>		LTP-XX-RGBYY-H90
<b>Electrical</b>	Input Voltage	24V DC
	Power Consumption	4.3W/Ft
<b>Specs</b>	Colour Temperature	RGBW
	CRI	90+
	Beam Angle	120°
<b>LED</b>	Type	High Brightness 5050 SMD LEDs
	Life Span	50,000 Hours
	Spacing	16mm
	# per foot (304mm)	18
<b>Design</b>	Dimensions (Inches)	.47" W
	Dimensions (Millimeters)	12mm W
	Max Single Run Length	20Ft
	Custom Cuttable	4"
	Approved Location	Indoor
<b>Warranty</b>	6 years	
<b>Approvals</b>	cETLus	

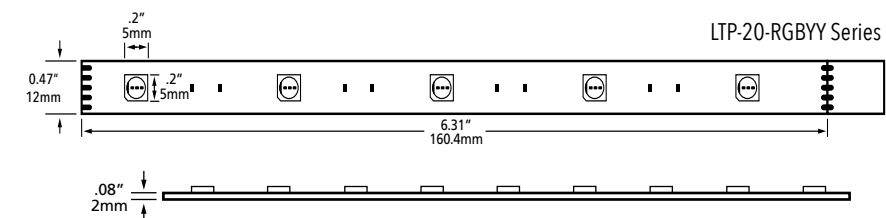

### PRODUCT CODES

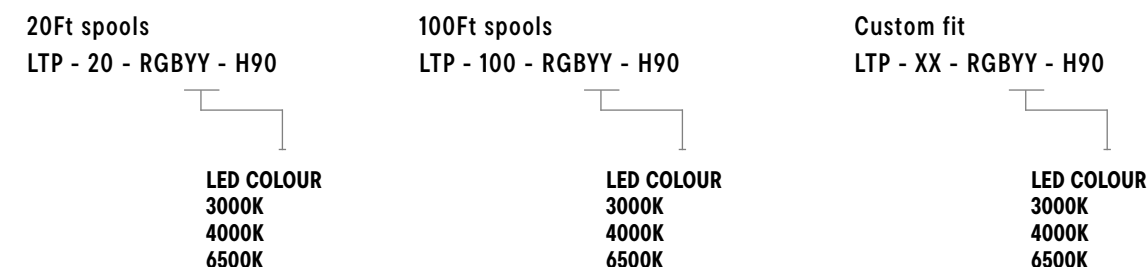

### ACCESSORIES

**LTP-001-RGBW-6**  
72" Power feed connector for RGBW indoor

**LTP-002-RGBW**  
In-line connector for RGBW indoor

**LTP-001-RGBW-6IN**  
6" In-line connector for RGBW indoor

**LT-WIFI-RM**  
4-Zone RGB+CCT Remote

**LT-WIFI-CTRL**  
3 IN 1 LED Strip Controller (WiFi+2.4G)

**LT-WIFI-AMP**  
WiFi Signal Amplifier for RGB, RGBW, CCT

**NOTE:** See page 35-36 for the complete range of aluminum extrusions.

### NON DIMMABLE DRIVERS

**LEDDR-24-120W**  
Indoor/Outdoor driver  
Max 17.6 (5.3m) per single tap  
Max 23' (7m) combined 2 secondary taps  
Input: 100 - 240V AC  
Output: 24V DC  
10" x 3 3/8" x 3 3/16" (254 x 85.7 x 80.9mm)

# Low Power Indoor

Great choice for under cabinet and coves offering subtle lighting effects.



## HIGH POWER SINGLE COLOUR LTP-20 SERIES

### FEATURES

- 1 Bin
- 2 Step MacAdam Ellipse
- 3oz PCB board
- 3M Adhesive
- 50,000 hours life
- High brightness 5060 SMD LEDs
- Field cuttable
- Low power consumption
- Available in 20' (6.1m) and 100' (30.48m) spools (custom cuts available)
- Safe, 24V class 2 power supplies (sold separately)
- Fully dimmable with dimmable power supplies (sold separately)
- 20' spools come with 6 ft. pre-soldered power feeds
- 6 years limited warranty

### APPLICATIONS

- Aisle and stairway lighting
- Cabinet and cove lighting
- Back lighting
- Showcase lighting
- Linear decorative lighting

SPECIFICATIONS		
<b>Product Code</b>	LTP-XX-YY-H90-LP	
<b>Electrical</b>	<b>Input Voltage</b>	24V DC
	<b>Power Consumption</b>	2.2W/Ft
<b>Specs</b>	<b>Colour Temperature</b>	2700/3000/3500/4000/6500K
	<b>CRI</b>	90
	<b>Lumen Output</b>	143 Lumens per ft 2700K; 145 Lumens per ft 3000K; 148 Lumens per ft 3500K; 150 Lumens per ft 4000K; 165 Lumens per ft 6500K
	<b>Efficacy</b>	65 LPW 2700K, 66 LPW 3000K, 68 LPW 3500K 70 LPW 4000K, 75 LPW 6500K
	<b>Dimmable</b>	Yes
	<b>Beam Angle</b>	120°
<b>LED</b>	<b>Type</b>	High Brightness 5060 SMD LEDs
	<b>Life Span</b>	50,000 Hours
	<b>Spacing</b>	32mm
	<b># per foot (304mm)</b>	9
<b>Design</b>	<b>Dimensions (Inches)</b>	.39" W
	<b>Dimensions (Millimeters)</b>	10mm W
	<b>Max Single Run Length</b>	40Ft
	<b>Custom Cuttable</b>	1.3" (33mm)
	<b>Approved Location</b>	Indoor
<b>Warranty</b>	6 years	
<b>Approvals</b>	cETLus	

### PRODUCT CODES

20Ft spools  
LTP - 20 - YY - H90 - LP

**LED COLOUR**  
2700K  
3000K  
3500K  
4000K  
6500K

100Ft spools  
LTP - 100 - YY - H90 - LP

**LED COLOUR**  
2700K  
3000K  
3500K  
4000K  
6500K

Custom fit  
LTP - XX - YY - H90 - LP

**LED COLOUR**  
2700K  
3000K  
3500K  
4000K  
6500K

LTP - 20 - YY - LP

**LED COLOR**  
RD: Red  
AM: Amber  
GR: Green  
BL: Blue

LTP - 100 - YY - LP

**LED COLOR**  
RD: Red  
AM: Amber  
GR: Green  
BL: Blue

LTP - XX - YY - LP

**LED COLOR**  
RD: Red  
AM: Amber  
GR: Green  
BL: Blue

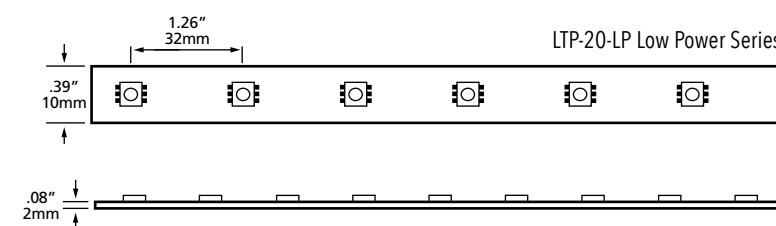

### DIMMABLE DRIVERS

#### TRE24L40DC

Max recommended load 36W or 16' LED Strip, min 8W or 4' LED Strip  
6.77" x 2.67" x 1.26" (171 x 68 x 32mm)

#### TRE24L96DC

Max recommended load 90W or 40' LED Strip, min 8W or 4' LED Strip  
6.77" x 2.67" x 1.26" (171 x 68 x 32mm)

### NON DIMMABLE DRIVERS

#### LEDDR-24-120W

Indoor/Outdoor driver  
Max. recommended load 90W or 40' (12.1m) per single tap, 120W or 54' (16.4m) combined two secondary taps.  
120W hardwire  
Input: 100 - 240V AC  
Output: 24V DC  
10" x 3 3/8" x 3 3/16" (254 x 85.7 x 80.9mm)

### ACCESSORIES



**LTP-001-6R**  
72" Power feed connector for high density indoor

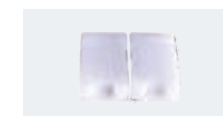

**LTP-002**  
In-line connector for CCT series indoor

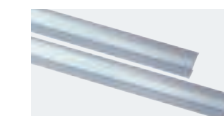

**LTP-010-S**  
Clear PVC mounting "U" channel



**LTP-003-6DC**  
DC connector for LED TAPE LIGHT with 6" wire and DC connector



**LTP-STP-6IN**  
5.9" (15cm)  
**LTP-STP-2IN**  
2" (5cm)  
**LTP-STP-2**  
2" (61cm)  
**LTP-STP-12**  
12" (3.65m)



**LMSII-001**  
Terminal block and junction box for connection to additional lengths of power cable if needed



**LV-SPIR-1CH-LV**  
PIR Motion Sensor, 1 Channel, 24V DC  
NOTE: To be used with non dimmable drivers only

# Low Power Outdoor

This exterior rated tape offers more subtle illumination approach for commercial, hospitality and residential usage.



## LOW POWER SINGLE COLOUR LTP-OD-LP SERIES

### FEATURES

- 1 Bin
- 2 Step MacAdam Ellipse
- 3oz PCB board
- 3M Adhesive
- 50,000 hours life
- High brightness 5060 SMD LEDs
- Field cuttable
- Low power consumption
- Available in 20' (6.1m) spools
- Safe, 24V class 2 power supplies (sold separately)
- Fully dimmable with dimmable power supplies (sold separately)
- 6 year limited warranty

### APPLICATIONS

- Aisle and stairway lighting
- Cabinet and cove lighting
- Back lighting
- Showcase lighting
- Linear decorative lighting

SPECIFICATIONS		
<b>Product Code</b>	LTP-OD-20-YY-H90-LP	
<b>Electrical</b>	Input Voltage	24V DC
	Power Consumption	2.2W/Ft
<b>Specs</b>	Colour Temperature	2700/3000/3500/4000/6500K
	CRI	90
	Lumen Output	143 Lumens per ft 2700K; 145 Lumens per ft 3000K; 148 Lumens per ft 3500K; 150 Lumens per ft 4000K; 165 Lumens per ft 6500K
	Efficacy	65 LPW 2700K, 66 LPW 3000K, 68 LPW 3500K 70 LPW 4000K, 75 LPW 6500K
	Dimmable	Yes
	Beam Angle	120°
<b>LED</b>	Type	High Brightness 5060 SMD LEDs
	Life Span	50,000 Hours
	Spacing	1.26" (32mm)
	# per foot (304mm)	9
<b>Design</b>	Dimensions (Inches)	.39" W
	Dimensions (Millimeters)	10mm W
	Max Single Run Length	40Ft
	Custom Cuttable	6.5" (165mm)
	Approved Location	Outdoor
<b>Warranty</b>	6 years	
<b>Approvals</b>	cETLus	

NOTE: Outdoor TAPE LIGHT comes with liquid-tight connectors pre-installed on both ends, so it is necessary to make the cuts starting from extremities. Cut pieces can be terminated, but not joined together.

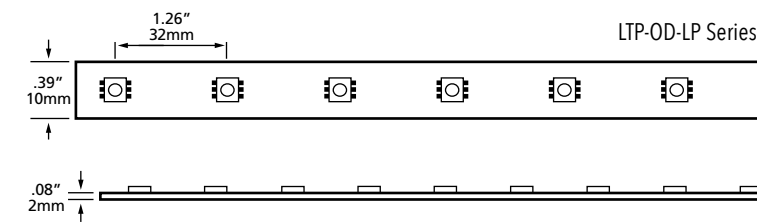

### PRODUCT CODES

LTP - OD - 20 - YY - H90 - LP

**LED COLOUR**  
**2700K**  
**3000K**  
**3500K**  
**4000K**  
**6500K**

### ACCESSORIES



**LTP-001-OD-6FT**  
72" Power feed connector for single colour outdoor



**LV-FS-MC-004**  
Mounting clips



**LV-FS-EC-001**  
End caps



**LTP-010-S**  
Clear PVC mounting "U" channel

NOTE: See page 35-36 for the complete range of aluminum extrusions.

### INDOOR/OUTDOOR DIMMABLE DRIVERS

#### TRE24L40DC

Max 7' (2.1m)  
Min 8 Watts, 1.5'(0.45M) LED High Efficacy Strip  
6.77" x 2.67" x 1.26" (171 x 68 x 32mm)

#### TRE24L96DC

Max recommended load 90W or 16' LED Strip,  
min 8W or 2' LED Strip  
6.77" x 2.67" x 1.26" (171 x 68 x 32mm)

NOTE: For outdoor installations, please add E-KO-SR strain relief (2pcs/driver).

### NON DIMMABLE DRIVERS

#### LEDDR-24-120W

Indoor/Outdoor driver  
Max. recommended load 90W or 40' (12.1m) per single tap,  
120W or 54' (16.46m) combined two secondary taps.  
120W hardwire  
Input: 100 - 240V AC  
Output: 24V DC  
10" x 3 3/8" x 3 3/16" (254 x 85.7 x 80.9mm)



# Low Power, RGB Indoor

For more subtle approaches within entertainment venues and restaurants.



## LOW POWER RGB LTP-20-RGB-LP SERIES

### FEATURES

- 50,000 hours life
- High brightness 5060 SMD LEDs
- Field cuttable
- Low power consumption
- Available in 20' (6.1m) and 100' (30.48m) spools (custom cuts available)
- 20' spools come with 6 ft. pre-soldered power feeds
- Safe, 24V class 2 power supplies (sold separately)
- 6 years limited warranty

### APPLICATIONS

- Aisle and stairway lighting
- Cabinet and cove lighting
- Back lighting
- Showcase lighting
- Linear decorative lighting

### SPECIFICATIONS

Product Code		LTP-XX-RGB-LP
Electrical	Input Voltage	24V DC
	Power Consumption	2.2W/Ft
Specs	Colour Temperature	RGB
	Dimmable	Yes
	Beam Angle	120°
LED	Type	High Brightness 5060 SMD LEDs
	Life Span	50,000 Hours
	Spacing	32mm
	# per foot (304mm)	9
Design	Dimensions (Inches)	.39" W
	Dimensions (Millimeters)	10mm W
	Max Single Run Length	40Ft
	Custom Cuttable	6.5"
	Approved Location	Indoor
Warranty	6 years	
Approvals	cETLus	

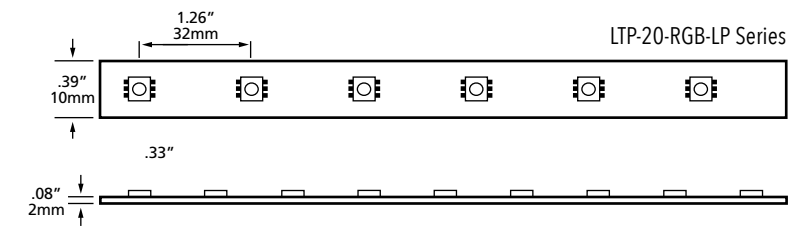

### PRODUCT CODES

20Ft spools LTP - 20 - RGB - LP	100Ft spools LTP - 100 - RGB - LP	Custom Cuts LTP - XX - RGB - LP
------------------------------------	--------------------------------------	------------------------------------

### ACCESSORIES



**LTP-001-RGB-6R**  
72" Power feed connector for RGB indoor. Add "-O" for opposite end

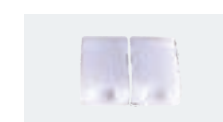

**LTP-002-RGB**  
In-line connector for RGB indoor

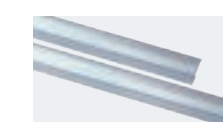

**LTP-010-S**  
Clear PVC mounting "U" channel



**LTP-001-RGB-6IN**  
6" In-line connector for RGB indoor



**LT-WIFI-AMP**  
WiFi Signal Amplifier for RGB, RGBW, CCT



**LT-WIFI-RM**  
4-Zone RGB+CCT Remote



**LT-WIFI-CTRL**  
3 IN 1 LED Strip Controller (WiFi+2.4G)

**LTP-001-RGB-2IN**  
2" In-line connector for RGB indoor

**NOTE:** See page 35-36 for the complete range of aluminum extrusions.

### NON DIMMABLE DRIVERS

**LEDDR-24-120W**  
Indoor/Outdoor driver  
Max 17.6 (5.3m) per single tap  
Max 23' (7m) combined 2 secondary taps  
Input: 100 - 240V AC  
Output: 24V DC  
10" x 3 3/8" x 3 3/16" (254 x 85.7 x 80.9mm)

# Low Power, RGB Outdoor



For those exterior applications requiring a dynamic but subtle approach. Suitable for residential, hospitality, commercial and retail.

## LOW POWER RGB LTP-OD-RGB-LP SERIES

### FEATURES

- 50,000 hours life
- High brightness 5060 SMD LEDs
- Field cuttable
- Low power consumption
- Available in 20' (6.1m) spools
- Safe, 24V class 2 power supplies (sold separately)
- 6 years limited warranty

### APPLICATIONS

- Aisle and stairway lighting
- Cabinet and cove lighting
- Back lighting
- Showcase lighting
- Linear decorative lighting

### SPECIFICATIONS

<b>Product Code</b>		LTP-OD-20-RGB-LP
<b>Electrical</b>	Input Voltage	24V DC
	Power Consumption	2.2W/Ft
<b>Specs</b>	Colour Temperature	RGB
	Dimmable	Yes
	Beam Angle	120°
<b>LED</b>	Type	High Brightness 5060 SMD LEDs
	Life Span	50,000 Hours
	Spacing	32mm
	# per foot (304mm)	9
<b>Design</b>	Dimensions (Inches)	.39" W
	Dimensions (Millimeters)	10mm W
	Max Single Run Length	40Ft
	Custom Cuttable	6.5"
	Approved Location	Outdoor
<b>Warranty</b>	6 years	
<b>Approvals</b>	cETLus	

**NOTE:** Outdoor TAPE LIGHT comes with liquid-tight connectors pre-installed on both ends, so it is necessary to make the cuts starting from extremities. Cut pieces can be terminated, but not joined together.

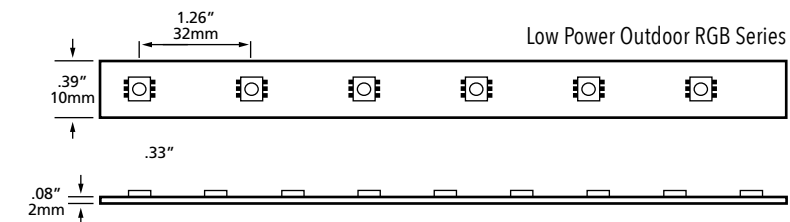

### PRODUCT CODES

20Ft spools  
LTP - OD - 20 - RGB - LP

### ACCESSORIES



**LTP-RGB-001-OD-6FT**  
72" Power feed connector for RGB outdoor



**LV-FS-MC-004**  
Mounting clips



**LV-FS-EC-001**  
End caps



**LTP-010-S**  
Clear PVC mounting "U" channel



**LT-WIFI-RM**  
4-Zone RGB+CCT Remote



**LT-WIFI-CTRL**  
3 IN 1 LED Strip Controller (WiFi+2.4G)



**LT-WIFI-AMP**  
WiFi Signal Amplifier for RGB, RGBW, CCT

**NOTE:** See page 35-36 for the complete range of aluminum extrusions.

### NON DIMMABLE DRIVERS

**LEDDR-24-120W**  
Indoor/Outdoor driver  
Max. recommended load 90W or 40' (12.1m) per single tap, 120W or 54' (16.46m) combined two secondary taps.  
120W hardwire  
Input: 100 - 240V AC  
Output: 24V DC  
10" x 3 3/8" x 3 3/16" (254 x 85.7 x 80.9mm)

# LED TAPE LIGHT Extrusions

These are designed to house and protect LED strip lights, enhancing durability and providing a sleek, professional finish. They also help to diffuse light evenly, preventing hotspots and creating a more aesthetically pleasing lighting effect..

## LV-ALP2208

Surface mount aluminum extrusion and frosted PC cover



### Product Codes

LV-ALP2208  
LV-ALP2208-2M

### End Caps

LV-ALP2208-EC (2/bag)  
LV-ALP2208-EC-WF (2/bag)

### Mounting Clips

LV-ALP2208-MC (2/bag)

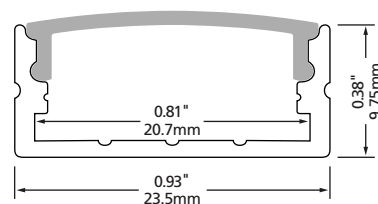

NOTE: Available in 1m (39") and 2m (78") lengths.

## LV-LB-V3-FR

Corner surface mounted aluminum extrusion and frosted PC cover

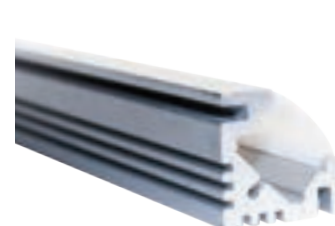

### Product Code

LV-LB-V3-FR

### End Caps

LV-V1/V3-EC (2/bag)  
LV-V1/V3-EC-WF (2/bag)

### Mounting Clips

LV-V1/V3-MC (6/bag)

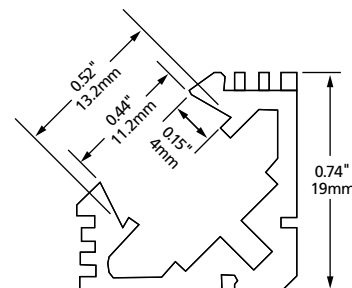

NOTE: Available in 1m (39").

## LV-ALP007

Surface mount aluminum extrusion and frosted PC cover



### Product Codes

LV-ALP2207  
LV-ALP2207-2M

### End Caps

LV-ALP007-EC (2/bag)  
LV-ALP007-EC-WF (2/bag)

### Mounting Clips

LV-ALP007-MC (6/bag)

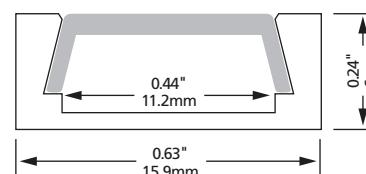

NOTE: Available in 1m (39") and 2m (78") lengths.

## LV-RD54

Surface mount aluminum extrusion

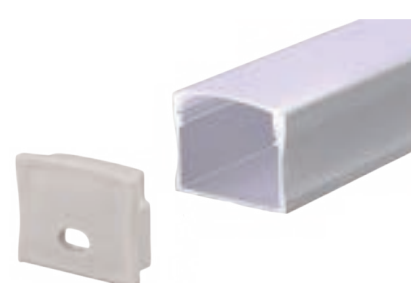

### Product Codes

LV-RD54-1M  
LV-RD54-2M

### End Caps

LV-RD54/55-EC (2/bag)  
LV-RD54/55-EC-WF (2/bag)

### Mounting Clips

LV-RD54/55-EC-MC (6/bag)

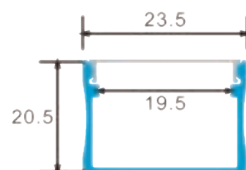

NOTE: Available in 1m (39") and 2m (78") lengths.

## LV-RD55

Surface mount aluminum extrusion



### Product Codes

LV-RD55-1M  
LV-RD55-2M

### End Caps

LV-RD54/55-EC (2/bag)  
LV-RD54/55-EC-WF (2/bag)

### Mounting Clips

LV-RD54/55-EC-MC (6/bag)

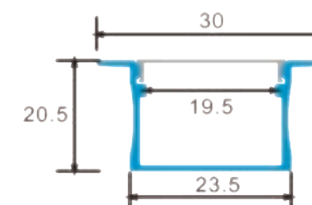

NOTE: Available in 1m (39") and 2m (78") lengths.

## LV-ALP2908

Recessed aluminum extrusion and frosted PC cover



### Product Codes

LV-ALP2908  
LV-ALP2908-2M

### End Caps

LV-ALP2908-EC (2/bag)  
LV-ALP2908-EC-WF (2/bag)

### Mounting Clips

LV-ALP2908-MC (2/bag)

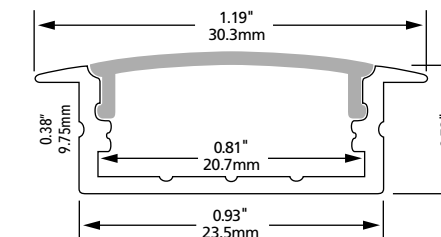

NOTE: Available in 1M (39") and 2M (78") lengths.

## LV-1401

Closet aluminum extrusion with mounting brackets and frosted PC cover

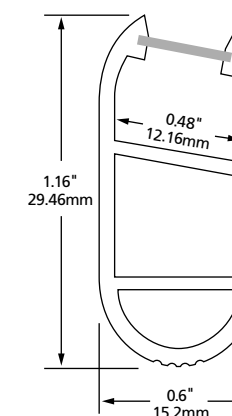

NOTE: 1M (39") extrusion ships complete with two mounting end caps and one support

# 120V AC eStrip

An ideal solution for accent lighting in residential, commercial and retail applications, the 120V AC LED eStrip can be easily installed without the need of any additional driver, in indoor and outdoor applications.



## FEATURES

- 120V AC input voltage
- High light efficiency, high PF and high lumens
- Constant current design, overvoltage protection
- Drop current when over temperature to protect product (Max. ambient working temperature: 55°C, light up for no more than 6 hours)
- Dimmable: TRIAC
- Do not need transformer box to change AC to DC, connect with line voltage directly
- Ambient Working Temperature: -20 ~ 42°C (-4 ~ 107°F)
- IP65 PVC extrusion process
- Min.section 4 inch; Max.run 164FT
- With bared power cords on one side, it's more convenient for connecting
- ETL certified
- 5 years warranty indoor use; 3 years warranty outdoor use

## APPLICATIONS

- Building outlines
- Signage
- Decks
- Architectural features

## SPECIFICATIONS

Product Code		ES-120V-27K-164FT	ES-120V-30K-164FT	ES-120V-40K-164FT
Electrical	Input Voltage	120V AC		
	Power Consumption	4W/Ft		
Specs	Color Temperature	2700K	3000K	4000K
	Efficacy (LM/Ft)	280LM	300LM	340LM
	CRI	90+		
	Dimmable	Yes		
LED	Type	SMD2835		
	Life Span	30,000 Hours		
	Spacing	N/A		
	# per foot (304mm)	18 LEDs		
Design	Dimensions (Inches)	.79" W		
	Dimensions (Millimeters)	20mm W		
	Max Single Run Length	50M (164Ft)		
	Custom Cuttable	Cuttable every 10CM (3 15/16") – Factory only		
	Approved Location	Indoor/Outdoor		
Warranty	5 years warranty indoor use; 3 years warranty outdoor use			
Approvals	cETLus			



## PRODUCT CODES

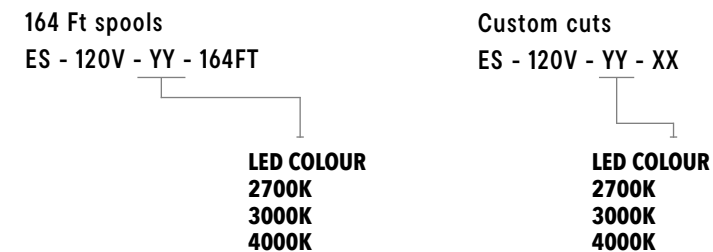

## ACCESSORIES

**ES-120V-EC**  
End cap (Indoor & Outdoor)

**ES-120V-EXT**  
4ft Aluminum extrusion

**ES-120V-MC**  
Mounting clips (Bag of 20)

**ES-120V-PC**  
8Ft Power cord

**ES-120V-PC-PL**  
5Ft Power cord with plug

**ES-120V-JC-1FT**  
Jumper, 1Ft

**ES-120V-JC-3FT**  
Jumper, 3Ft

**ES-120V-JC-6FT**  
Jumper, 6Ft

**ES-120V-JC-6IN**  
Jumper, 6"

# Low Power eStrip

The Low Power LED eStrip, equipped with 3014 type LEDs, is a versatile linear lighting solution that offers improved brightness and performance



## FEATURES

- 40,000 hours life
- Safe low voltage (24V)
- Virtually maintenance free
- Ultra low power consumption
- Available in 40' spools (custom cuts available)
- Crushproof to 100psi
- Field cuttable
- Inter-connectable
- Highly flexible (min. bend radius 1.5")
- Indoor/outdoor use
- Impact resistant
- Dimmable
- 2 years limited warranty

## APPLICATIONS

- Building outlines
- Coves
- Stairway and aisle lighting
- Signage
- Backlit panels
- Decks
- Edgelit glow
- Emergency lighting
- Pathway lighting
- Billboards
- Highlighting architectural features
- Over/Under cabinets

## SPECIFICATIONS

<b>Product Code</b>		LES-XX-YY
<b>Electrical</b>	<b>Input Voltage</b>	24V DC
	<b>Power Consumption</b>	0.96W/Ft
<b>Specs</b>	<b>Colour Temperature</b>	3000/5800K
	<b>Lumen Output</b>	61 Lumens per ft. 5800K; 55 Lumens per ft. 3000K
	<b>LED Colours</b>	Amber, Red, Blue, Pure Green, 5800K, 3000K
	<b>PVC Body Colour</b>	Clear
	<b>Min/Max Surface Temp for Mounting</b>	-40°C - 40°C (-40°F - 104°F)
	<b>Dimmable</b>	Yes
	<b>Beam Angle</b>	120°
<b>LED</b>	<b>Type</b>	N/A
	<b>Life Span</b>	40,000 Hours
	<b>Spacing</b>	1" (25.4mm)
	<b># per foot (304mm)</b>	12
<b>Design</b>	<b>Dimensions (Inches)</b>	.25 x .5"
	<b>Dimensions (Millimeters)</b>	6 x 12mm
	<b>Max Single Run Length</b>	40Ft
	<b>Custom Cuttable</b>	6" (152.4mm)
	<b>Approved Location</b>	Indoor/Outdoor
<b>Warranty</b>	2 years	
<b>Approvals</b>	cETLus	

## PRODUCT CODES

90Ft spools  
LES - 90 - YY

**LED eStrip** **LED COLOUR**  
3000K, 5800K, AM - Amber,  
BL - Blue, PG - Pure Green, RD - Red

Custom cuts  
LES - XX - YY

**LED eStrip** **LED COLOUR**  
3000K, 5800K, AM - Amber,  
BL - Blue, PG - Pure Green, RD - Red

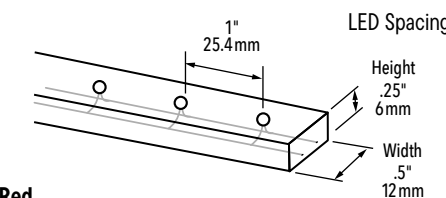

## ACCESSORIES



**LES-001-6BR**  
Outdoor 6' Power connector for burial connections, 1/4" x 1/2" (6mm x 12mm). Comes with end cap



**LES-001-12BR**  
Outdoor Power connector, with SJTW-2 12 ft wires for burial connections 1/4" x 1/2" (6mm x 12mm) Comes with end cap



**LES-STP-2BR**  
Outdoor 2' Step cord for burial connections



**LES-STP-12BR**  
Outdoor 12' Step cord (shown) for burial connections



**LES-FLEX-BR**  
Outdoor Step cord for burial connections

**LES-001-6CL**  
Indoor 6' Power connector for through wall connections

**LES-001-12CL**  
Indoor 12' Power connector for through wall connections

**LES-STP-2CL**  
Indoor 2' Step cord (shown) for through wall connections

**LES-STP-12CL**  
Indoor 12' Step cord for through wall connections

**LES-FLEX-CL**  
Indoor Step cord (shown) for through wall connections



**LMSII-001**  
Terminal block and junction box for connection to additional lengths of power cable if needed



**LES-BFLN**  
L type connector, 1/4" X 1/2" (6mm x 12mm)



**LES-002**  
In-Line connector set, male and female, 1/4" X 1/2" (6mm x 12mm)



**LES-BFTD**  
T type connector, 1/4" X 1/2" (6 x 12mm), male connector in bottom



**LES-003-2**  
Cutting end cap, 0.25" X 0.5" (6mm x 12mm)



**LES-BFTR**  
T type connector, 1/4" X 1/2" (6 x 12mm), male connector in right or left



**LES-005**  
Wood nail clips, 1/4" X 1/2" (6mm x 12mm)



**LES-008**  
Tie wrap and mounting saddle



**LES-BFXN**  
X type connector, 1/4" X 1/2" (6mm x 12mm)



**LES-BFDN**  
6 x 12mm splice kit (pins, pad and shrink tube)



**LES-010**  
4' plastic mounting channel, indoor use

**LES-010-S**  
Predrilled with screws

**LES-010-T**  
With double sided tape



**NN-C10-POLY**  
For outdoor use

## INDOOR/OUTDOOR DIMMABLE DRIVERS

**TRE24L40DC**  
Max 37.5' (11.4m)  
Min 8 Watts, 9' LED eStrip (2.7m)  
6.77" x 2.67" x 1.26" (171 x 68 x 32mm)

**TRE24L96DC**  
Max 90' (27.4m)  
Min 8 Watts, 9' LED eStrip (2.7m)  
6.77" x 2.67" x 1.26" (171 x 68 x 32mm)

## NON DIMMABLE DRIVERS

**LEDDR-24-120W** (Indoor/Outdoor driver)  
Max 90' (27.4m) per single tap  
Max 120' (36.5m) combined 2 secondary taps  
Input: 100 - 240V AC, Output: 24V DC  
10" x 3 3/8" x 3 3/16" (254 x 85.7 x 80.9mm)

**LES-24-65W**  
Indoor Plug In Driver  
Input: 100-240V AC  
Output: 24V DC

**NOTE:** For outdoor installations, please add E-KO-SR strain relief (2pcs/driver).

# High Power eStrip

The High Power LED eStrip is an advanced version that delivers twice the lumen output compared to the standard eSTRIP, enhancing illumination capabilities.



## FEATURES

- 40,000 hours life
- Safe low voltage (24V)
- Virtually maintenance free
- Ultra low power consumption
- Available in 40' spools (custom cuts available)
- Crushproof to 100psi
- Field cuttable
- Inter-connectable
- Highly flexible (min. bend radius 1.5")
- Indoor/outdoor use
- Impact resistant
- Dimmable
- 2 years limited warranty

## APPLICATIONS

- Building outlines
- Coves
- Stairway and aisle lighting
- Signage
- Backlit panels
- Decks
- Edgelit glow
- Emergency lighting
- Pathway lighting
- Billboards
- Highlighting architectural features
- Over/Under cabinets

## SPECIFICATIONS

<b>Product Code</b>		LESHP-XX-YY
<b>Electrical</b>	<b>Input Voltage</b>	24V DC
	<b>Power Consumption</b>	2.2W/Ft
<b>Specs</b>	<b>Colour Temperature</b>	3000/5800K
	<b>Lumen Output</b>	137 Lumens per ft 3000K; 155 Lumens per ft 5800K
	<b>LED Colours</b>	3000K and 5800K,
	<b>PVC Body Colour</b>	Clear
	<b>Min/Max Surface Temp for Mounting</b>	-40°C to 40°C (-40°F to 104°F)
	<b>Dimmable</b>	Yes
	<b>Beam Angle</b>	120°
<b>LED</b>	<b>Type</b>	N/A
	<b>Life Span</b>	40,000 Hours
	<b>Spacing</b>	1" (25.4mm)
	<b># per foot (304mm)</b>	12
<b>Design</b>	<b>Dimensions (Inches)</b>	.25 x .5"
	<b>Dimensions (Millimeters)</b>	6 x 12mm
	<b>Max Single Run Length</b>	40Ft
	<b>Custom Cuttable</b>	6" (152.4mm)
	<b>Approved Location</b>	Indoor/Outdoor
<b>Warranty</b>	2 years	
<b>Approvals</b>	cETLus	

## PRODUCT CODES

40Ft spools

LESHP - 40 - YY

**HIGH POWER LED eStrip**

**LED COLOUR 3000K 5800K**

Custom Cuts

LESHP - XX - YY

**HIGH POWER LED eStrip**

**LED COLOUR 3000K 5800K**

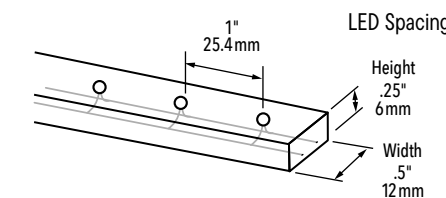

## ACCESSORIES



**LES-001-6BR**  
Outdoor 6' Power connector for burial connections, 1/4" x 1/2" (6mm x 12mm). Comes with end cap



**LES-001-12BR**  
Outdoor Power connector, with SJTW-2 12 ft wires for burial connections 1/4" x 1/2" (6mm x 12mm) Comes with end cap



**LES-STP-2BR**  
Outdoor 2' Step cord for burial connections



**LES-STP-12BR**  
Outdoor 12' Step cord (shown) for burial connections



**LES-FLEX-BR**  
Outdoor Step cord for burial connections

**LES-001-6CL**  
Indoor 6' Power connector for through wall connections

**LES-001-12CL**  
Indoor 12' Power connector for through wall connections

**LES-STP-2CL**  
Indoor 2' Step cord (shown) for through wall connections

**LES-STP-12CL**  
Indoor 12' Step cord for through wall connections

**LES-FLEX-CL**  
Indoor Step cord (shown) for through wall connections



**LMSII-001**  
Terminal block and junction box for connection to additional lengths of power cable if needed



**LES-BFLN**  
L type connector, 1/4" X 1/2" (6mm x 12mm)



**LES-002**  
In-Line connector set, male and female, 1/4" X 1/2" (6mm x 12mm)



**LES-BFTD**  
T type connector, 1/4" X 1/2" (6 x 12mm), male connector in bottom



**LES-003-2**  
Cutting end cap, 0.25" X 0.5" (6mm x 12mm)



**LES-BFTR**  
T type connector, 1/4" X 1/2" (6 x 12mm), male connector in right or left



**LES-005**  
Wood nail clips, 1/4" X 1/2" (6mm x 12mm)



**LES-008**  
Tie wrap and mounting saddle



**LES-BFXN**  
X type connector, 1/4" X 1/2" (6mm x 12mm)

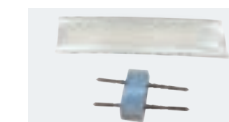

**LES-BFDN**  
6 x 12mm splice kit (pins, pad and shrink tube)

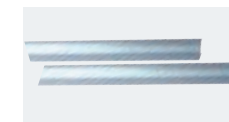

**LES-010**  
4' plastic mounting channel, indoor use

**LES-010-S**  
Predrilled with screws

**LES-010-T**  
With double sided tape

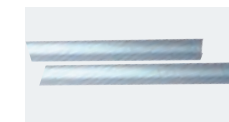

**NN-C10-POLY**  
For outdoor use

## INDOOR/OUTDOOR DIMMABLE DRIVERS

**TRE24L40DC**  
Max 7' (2.1m)  
Min 8 Watts, 1.5'(0.45M) LED High Efficacy Strip  
6.77" x 2.67" x 1.26" (171 x 68 x 32mm)

**TRE24L96DC**  
Max recommended load 90W or 16' LED Strip,  
min 8W or 2' LED Strip  
6.77" x 2.67" x 1.26" (171 x 68 x 32mm)

## NON DIMMABLE DRIVERS

**LEDDR-24-120W** (Indoor/Outdoor driver)  
Max 40' (12m) per single tap  
Max 54' (16.4m) combined 2 secondary taps  
Input: 100 - 240V AC, Output: 24V DC  
10" x 3 3/8" x 3 3/16" (254 x 85.7 x 80.9mm)

**LES-24-65W**  
Indoor Plug In Driver  
Input: 100-240V AC  
Output: 24V DC  
4.7" x 2" x 1.3" (119.4 x 50.8 x 33mm)

**NOTE:** For outdoor installations, please add E-KO-SR strain relief (2pcs/driver).

# RGB eStrip

The RGB eSTRIP, featuring RGB LEDs, enables the creation of dramatic color change effects, suitable for building outlines and architectural highlights.



## FEATURES

- 40,000 hours life
- Safe low voltage (24V)
- Virtually maintenance free
- Ultra low power consumption
- Available in 40' spools (custom cuts available)
- Crushproof to 100psi
- Field cuttable
- Inter-connectable
- Highly flexible (min. bend radius 1.5")
- Indoor/outdoor use
- Impact resistant
- Dimmable
- 2 years limited warranty

## APPLICATIONS

- Building outlines
- Coves
- Stairway and aisle lighting
- Signage
- Backlit panels
- Decks
- Edgelit glow
- Emergency lighting
- Pathway lighting
- Billboards
- Highlighting architectural features
- Over/Under cabinets

## SPECIFICATIONS

<b>Product Code</b>		LES-XX-RGB
<b>Electrical</b>	<b>Input Voltage</b>	24V DC
	<b>Power Consumption</b>	2.2W/Ft
<b>Specs</b>	<b>Colour Temperature</b>	RGB
	<b>PVC Body Colour</b>	Clear
	<b>Min/Max Surface Temp for Mounting</b>	-40°C - 40°C (-40°F - 104°F)
	<b>Dimmable</b>	Yes
<b>LED</b>	<b>Beam Angle</b>	120°
	<b>Type</b>	N/A
	<b>Life Span</b>	40,000 Hours
	<b>Spacing</b>	1.3" (33mm)
<b>Design</b>	<b># per foot (304mm)</b>	9
	<b>Dimensions (Inches)</b>	.3" x .6"
	<b>Dimensions (Millimeters)</b>	7.6 x 15mm
	<b>Max Single Run Length</b>	40Ft
	<b>Custom Cuttable</b>	8" (198mm)
<b>Approved Location</b>	Indoor/Outdoor	
<b>Warranty</b>		2 years
<b>Approvals</b>		cETLus

## PRODUCT CODES

40Ft spools  
LES - 40 - RGB

Custom cuts  
LES - XX - RGB

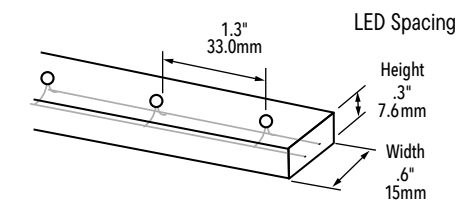

## ACCESSORIES



**LES-BTFN**  
Female connector



**LES-BTMN**  
Male connector



**LES-BTSN**  
In line connector



**LES-BTMCJ-1.5**  
1.5' Power connector



**LES-BTMCJ-6**  
6' Power connector



**LES-BTMC-G4-SI**  
Signal in connector for RGB eStrip connection to outdoor signal amplifier



**LES-BTMC-G4-SO**  
Signal out connector for RGB eStrip connection to outdoor signal amplifier



**LES-001-OD-6FT**  
Power feed connector for connection to outdoor signal amplifier



**LES-STCN**  
Cutting end cap



**LES-STFN**  
Female end cap



**LES-STPV-T**  
Clear PVC mounting "U" channel (1M)



**LES-SNPT**  
Wood nail clips, 1/4" X 1/2" (6mm x 12mm)



**LES-C-6**  
Tie wrap



**LES-MX-1**  
Allen key



**TCJ-E06**  
6' (1.8m) Extension cord

**TCJ-E30**  
30' (9.1m) Extension cord 1/4" x



**LES-TCJ-EI6-N**  
LED RGB eStrip 6" Flex Connector



**LT-WIFI-RM**  
4-Zone RGB+CCT Remote



**LT-WIFI-CTRL**  
3 IN 1 LED Strip Controller (WiFi+2.4G)



**LT-WIFI-AMP**  
WiFi Signal Amplifier for RGB, RGBW, CCT

## NON DIMMABLE DRIVERS

**LEDDR-24-120W**  
Indoor/Outdoor driver  
Max 40' (12.1m) per single tap  
Max 54' (16.46m) combined 2 secondary taps  
Input: 100 - 240V AC, Output: 24V DC  
10" x 3 3/8" x 3 3/16" (254 x 85.7 x 80.9mm)

# Neon Flex

LED Neon Flex is a flexible lighting solution designed to accentuate architectural and design elements, adding color and vibrancy to building exteriors.



## FEATURES

- Virtually maintenance free
- Low power consumption
- Safe 24V DC operation
- cETLus certified
- Dimmable
- Inter-connectable
- Field cuttable (every 4" single colour, every 12" RGB)
- Custom cuts available
- Available in seven brilliant colours, and RGB
- Highly flexible, with neon look
- Indoor/outdoor use
- 30,000 hour life
- 3 years limited warranty

## APPLICATIONS

- Building outlines
- Stairway and aisle lighting
- Signs
- Decks
- Pathway lighting
- Billboards
- Highlighting architectural features

## SPECIFICATIONS

Product Code		NFLX-XX-YY
Electrical	Input Voltage	24V DC
	Power Consumption	2.44 W/Ft (8W/M)
Specs	Colour Temperature	3000K, 4000K, 6000K, Red, Green, Blue, Amber, RGB
	CRI	80+
	Lumen Output	61 LM/Ft (200LM/M)
	Efficacy	25 LPW
	PVC Body Colour	Clear
	Operating Temperature	-20°C - 40°C
	Dimmable	Yes
LED	Beam Angle	120°
	Type	N/A
	Life Span	30,000 Hours
	# per foot (304mm)	N/A
Design	Dimensions (Inches)	1.04 x 0.6"
	Dimensions (Millimeters)	26.5 x 15mm
	Max Single Run Length	40Ft
	Custom Cuttable	4" Single Colour, 12" RGB
	Approved Location	Indoor/Outdoor
Warranty		3 years
Approvals		cETLus

## PRODUCT CODES

NFLX - 40 - XX  
NFLX - XX - YY

LED Neon Flex Length Colour  
3000K, 4000K, 6000K, RD - Red, GR - Green, BL - Blue, AM - Amber, RGB - RGB

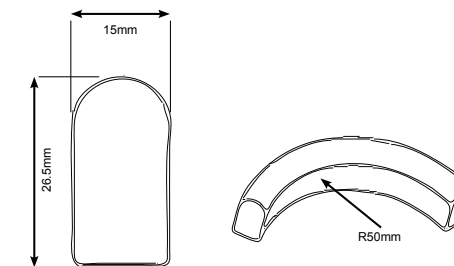

## ACCESSORIES (SINGLE COLOUR)

<b>NFLX-CONKIT-6FT</b> Power feed connector, 6FT	<b>NFLX-JUMP</b> Jumper connector, 15CM [6in]	<b>NFLX-PINS</b> Single colour pins	<b>NFLX-SPLICE</b> In-line splice connector	<b>NFLX-L-SPLICE</b> L splice connector
<b>NFLX-T-SPLICE</b> T splice connector	<b>NFLX-ENDS</b> End cap	<b>NFLX-CLIPS</b> Mounting clips	<b>NFLX-CHANNEL</b> Aluminum mounting channel 1M [3.28FT]	<b>NFLX-GLUE</b> Silicone Glue

## ACCESSORIES (RGB)

<b>NFLX-RGB-CONTROL</b> RGB controller	<b>NFLX-RGB-AMP</b> RGB signal amplifier	<b>NFLX-RGB-CONKIT-6FT</b> RGB power feed connector, 6FT	<b>NFLX-RGB-CONKIT-6FT-O</b> RGB power feed connector, 6FT, opposite	<b>NFLX-RGB-JUMP</b> RGB Jumper connector, 15cm (6 Inches)
<b>NFLX-PINS</b> Single colour pins	<b>NFLX-ENDS</b> End cap	<b>NFLX-CLIPS</b> Mounting clips	<b>NFLX-CHANNEL</b> Aluminum mounting channel 1M [3.28FT]	<b>NFLX-GLUE</b> Silicone Glue

## INDOOR/OUTDOOR DIMMABLE DRIVERS

**TRE24L40DC**  
Max 7' (2.1m)  
Min 8 Watts, 1.5'(0.45M) LED High Efficacy Strip  
6.77" x 2.67" x 1.26" (171 x 68 x 32mm)

**TRE24L96DC**  
Max recommended load 90W or 16' LED Strip,  
min 8W or 2' LED Strip  
6.77" x 2.67" x 1.26" (171 x 68 x 32mm)

## NON DIMMABLE DRIVERS

**LEDDR-24-120W**  
Indoor/Outdoor driver  
Max 40' (12m) per single tap  
Max 48' (14.6m) combined 2 secondary taps  
Input: 100 - 240V AC  
Output: 24V DC  
10" x 3 3/8" x 3 3/16" (254 x 85.7 x 80.9mm)

NOTE: For outdoor installations, please add E-KO-SR strain relief (2pcs/driver).



# Globe Light

The LED Globe Light, characterized by its marquee-style design, serves as a decorative lighting option equipped to endure extreme weather conditions, offering durability and longevity for both indoor and outdoor use.



## FEATURES

- 50,000 hours life
- Low power consumption
- Safe class 2, 24V power supply
- Field cuttable
- Multiple lamp spacings available
- Durable construction for indoor and outdoor use
- 2 years limited warranty

## APPLICATIONS

- Building outlines
- String across patios, walk ways, streets and public areas
- Under soffits
- Bridges
- Architectural features
- Window decorations
- Decks and patios

## SPECIFICATIONS

<b>Product Code</b>		MGST-12-Y
<b>Electrical</b>	Input Voltage	24V DC
	Power Consumption	.5W/Ft
<b>Specs</b>	Colour Temperature	2700/6000K
	CRI	80+
	Lumen Output	50 Lumens
	LED Colours	2700K, 6000K, Red, Blue, Green, Amber (Upon request)
	Efficacy	100 Lumens per watt
	Wiring	Directly wired to class 2, 24V power supply
	Dimmable	Yes
	Cable	PVC black SPT2, 16AWG outdoor rated
<b>Design</b>	Life Span	50,000 Hours
	Spacing	12"
	# per foot (304mm)	1
	Dimensions (Inches)	1.77 x 2.76"
	Dimensions (Millimeters)	45 x 70mm
<b>Warranty</b>	Finish	Black
	Max Single Run Length	150' (45.6M) Not to exceed 180 lamps
	Operating Temperature	-25°C to 65°C
	Approved Location	Indoor/Outdoor
<b>Warranty</b>		2 years
<b>Approvals</b>		cETLus

## PRODUCT CODES

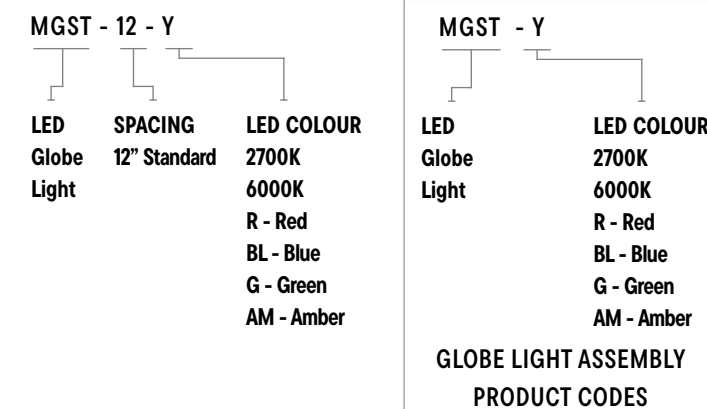

**OUTDOOR RATED CABLE: ST16W**  
For attaching Globe Light Lamp Assemblies.

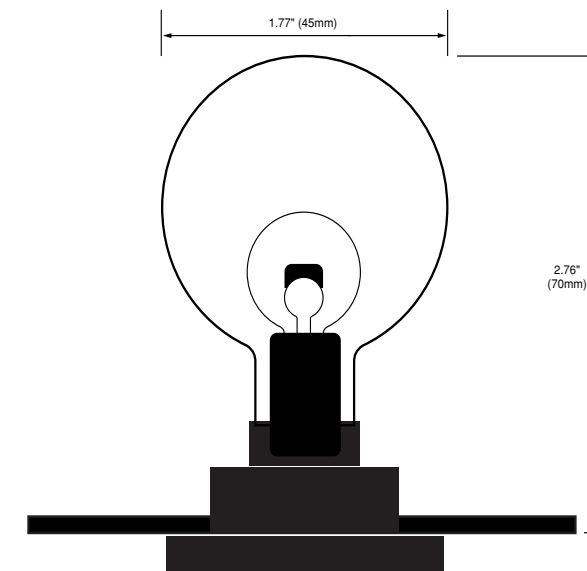

## ACCESSORIES

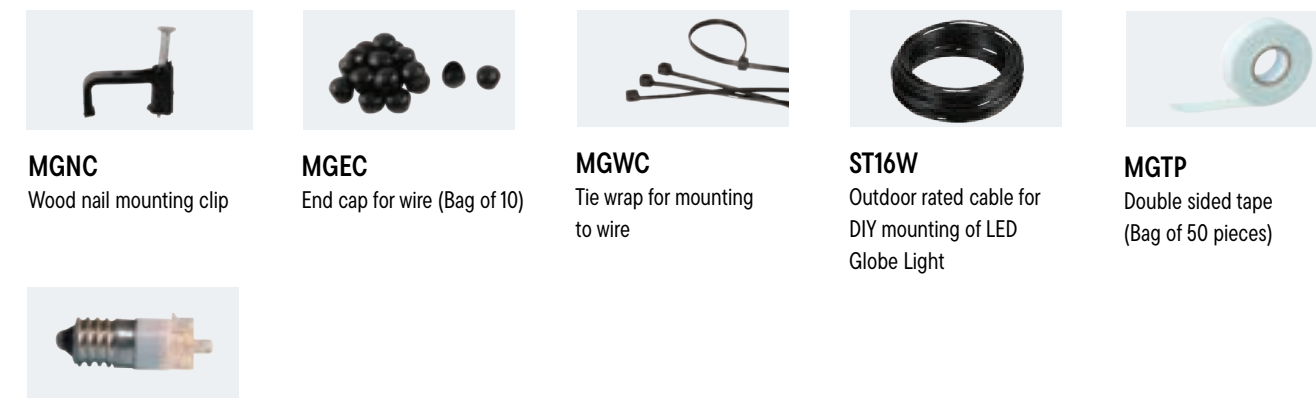

**MGST-XX-LAMP**  
Replacement lamp

## INDOOR/OUTDOOR DIMMABLE DRIVERS

**TRE24L40DC**  
Min 8 Watts, 16 Globes  
Max number of Globes = 80  
40 Watts  
6.77" x 2.67" x 1.26" (171 x 68 x 32mm)

**TRE24L96DC**  
Min 8 Watts, 16 Globes  
Max number of Globes = 180  
96 Watts  
6.77" x 2.67" x 1.26" (171 x 68 x 32mm)

## NON DIMMABLE DRIVERS

**LEDDR-24-120W**  
Indoor/Outdoor driver  
Max number of Globes = 180\*  
120W hardwire  
Input: 100 - 240V AC  
Output: 24V DC  
120 Watts  
10" x 3 3/8" x 3 3/16" (254 x 85.7 x 80.9mm)

\* 180 on a single tap or 200 combined two secondary taps.

# Wedge Light

The LED Wedge Light is designed as a durable lighting solution for all weather conditions, making it suitable for outlining buildings and various decorative lighting projects. Its robust construction ensures reliable performance in diverse environments.



## FEATURES

- 50,000 hours life
- Low power consumption
- Safe class 2, 12V power supply
- Field cuttable
- Multiple lamp spacings available
- Durable construction for indoor and outdoor use
- Available in Cool White and Warm White
- Optional Red, Blue, Green & Amber LEDs are also available
- 2 years limited warranty

## APPLICATIONS

- Building outlines
- Under soffits
- Bridges
- Architectural features
- Coves
- Window decorations
- Decks and patios

## SPECIFICATIONS

<b>Product Code</b>		MGST-06-Y
<b>Electrical</b>	<b>Input Voltage</b>	12V DC
	<b>Power Consumption</b>	.25W/Ft
<b>Specs</b>	<b>Colour Temperature</b>	2700/6000K
	<b>CRI</b>	80+
	<b>Lumen Output</b>	15 Lumens
	<b>LED Colours</b>	2700K, 6000K, Red, Blue, Green, Amber (Upon request)
	<b>Efficacy</b>	60 Lumens per watt
	<b>Wiring</b>	Directly wired to class 2, 24V power supply
	<b>Dimmable</b>	Yes
<b>Design</b>	<b>Cable</b>	PVC black SPT2, 16AWG outdoor rated
	<b>Life Span</b>	50,000 Hours
	<b>Spacing</b>	6"
	<b># per foot (304mm)</b>	2
	<b>Dimensions (Inches)</b>	1.02" x 1.46"
<b>Design</b>	<b>Dimensions (Millimeters)</b>	26 x 37mm
	<b>Finish</b>	Black
	<b>Max Single Run Length</b>	100' (45.6M) Not to exceed 200 lamps
	<b>Operating Temperature</b>	-25°C to 65°C
	<b>Approved Location</b>	Indoor/Outdoor
<b>Warranty</b>		2 years
<b>Approvals</b>		cETLus

## PRODUCT CODES

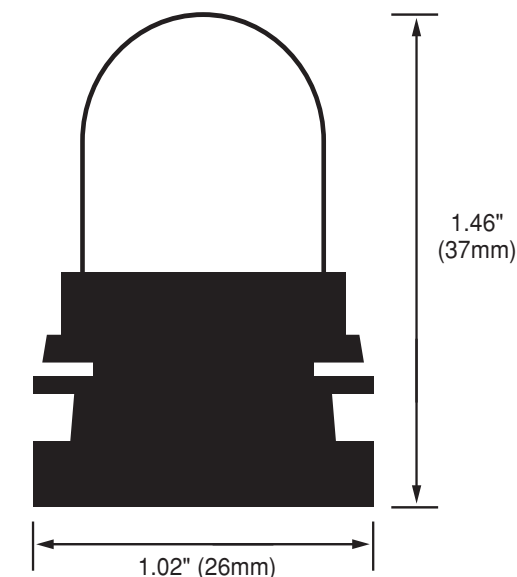
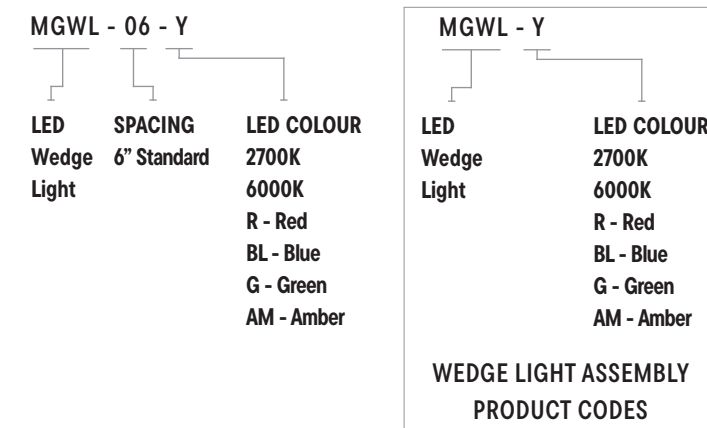

## ACCESSORIES

				
<b>MGNC</b> Wood nail mounting clip	<b>MGEC</b> End cap for wire (Bag of 10)	<b>MGWC</b> Tie wrap for mounting to wire	<b>ST16W</b> Outdoor rated cable for DIY mounting of LED Wedge Light	<b>MGTP</b> Double sided tape (Bag of 50 pieces)



**MGST-XX-LAMP**  
Replacement lamp

## INDOOR/OUTDOOR DIMMABLE DRIVERS

**TRE12L20DC**  
Min 8 Watts, 32 Wedges  
Max number of Wedges = 80  
20 Watts  
6.77" x 2.67" x 1.26" (171 x 68 x 32mm)

**TRE12L60DC**  
Min 8 Watts, 32 Wedges  
Max number of Wedges = 200  
60 Watts  
6.77" x 2.67" x 1.26" (171 x 68 x 32mm)

**NOTE:** For outdoor installations, please add E-KO-SR strain relief (2pcs/driver).

## NON DIMMABLE DRIVERS

**LEDDR-12-60W**  
Indoor/Outdoor driver  
Max number of Wedges = 200  
60W hardwire  
Input: 100 - 240V AC  
Output: 12V DC  
9 11/16" x 2 9/16" x 2 1/16" (246 x 65 x 52mm)

# 24V Wall Washer

The 24V LED Wall Washer is engineered for illuminating architectural features, signage, and landscapes with its advanced lighting capabilities. It provides a versatile solution for both indoor and outdoor spaces, combining functionality with aesthetic enhancement.

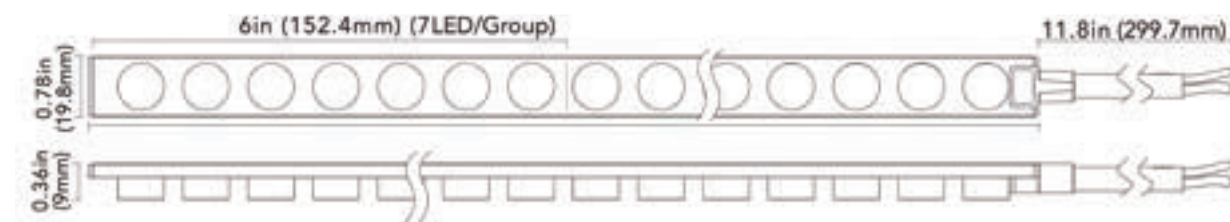

## FEATURES

- Safe 24V DC operation (Requires our 24V driver)
- Low power consumption: 5.8W/FT
- Suitable for indoor and outdoor use
- Beam angle: 30°
- Available in 2700K, 3000K, 4000K color temperatures
- Long life 30, 000 hours
- Dimmable with dimmable drivers
- Field cuttable every 6" (Maximum run is 16ft.)
- Sold in 33 Rolls
- cULus certified for wet locations
- 3 years limited warranty

## APPLICATIONS

- Architectural lighting
- Signage
- Landscape lighting
- Exterior/interior commercial

## ACCESSORIES



**NFLX-GLUE**  
Glue



**ES-EC**  
End Cap

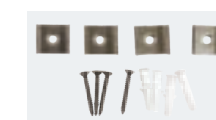

**ES-MC**  
Mounting Clips  
(4pcs/bag)



**ES-WB**  
Wall Washer Wall Bracket Set



**ES-PFC-6FT**  
Power Feed Connector



**ES-JC-6IN 6IN,**  
**ES-JC-12IN 12IN,**  
**ES-JC-3FT 3FT,**  
**ES-JC-6FT 6FT**  
Jumper Cable

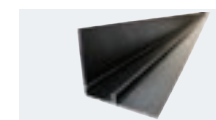

**ES-EXT**  
ES-EXT Aluminum extrusion (8FT), anodized black, for ceiling or floor mounting. For wall mounting, please see the wall mounting brackets.



Three wall mounting brackets available to enhance the wall washing effect:  
**ES-MB-2IN 2IN**  
**ES-MB-4IN 4IN**  
**ES-MB-6IN 6IN**  
Wall Mounting Bracket

SPECIFICATIONS				
<b>Product Code</b>	ES-LS2835-27K-42-24-30	ES-LS2835-30K-42-24-30	ES-LS2835-40K-42-24-30	
<b>Electrical</b>	Input Voltage	24V DC		
	Power Consumption	5.8W/Ft		
<b>Specs</b>	Color Temperature	2700K	3000K	4000K
	Efficacy	100LM/W	105LM/W	110LM/W
	Luminous Flux	580LM/FT	610LM/FT	640LM/FT
	CRI	90+		
	Dimmable	Yes		
	Beam Angle	30°		
<b>LED</b>	Type	SMD2835		
	Life Span	30,000 Hours		
	Spacing	N/A		
	# per foot (304mm)	14		
<b>Design</b>	Dimensions	8mm (5/16") x 15mm (9/16")		
	Max Single Run Length	16Ft		
	Custom Cuttable	Every 6"		
	Approved Location	Indoor/Outdoor		
	Mounting	Ceiling, floor		
<b>Warranty</b>	3 years			
<b>Approvals</b>	cULus for wet locations			

## INDOOR/OUTDOOR DIMMABLE DRIVERS

**TRE24L40DC**  
6.77" x 2.67" x 1.26" (171 x 68 x 32mm)

**TRE24L96DC**  
6.77" x 2.67" x 1.26" (171 x 68 x 32mm)

## NON DIMMABLE DRIVERS

**LEDDR-24-120W (Indoor/Outdoor)**  
120W hardwire  
Input: 100 - 240V AC  
Output: 24V DC  
10" x 3 3/8" x 3 3/16" (254 x 85.7 x 80.9mm)

**NOTE:** For field cuttability you will need power supply cap, End cap and potentially jumper cables. All termination points must be glued with our NFLX-GLUE. Please reach out if you have any questions, we would be happy to help.

# Wall Washer 4' Enclosed

This a type of lighting fixture designed to evenly distribute light over a wall or vertical surface. Enclosed within a 4-foot-long casing, this wall washer is designed for durability and protection against dust, moisture, and other environmental factors.



## FEATURES

- Safe 24V DC operation (Requires our 24V driver)
- Low power consumption: 5.8W/FT
- Suitable for indoor and outdoor use
- Beam angle: 30°
- Available in 2700K, 3000K, 4000K color temperatures
- Long life 30, 000 hours
- Dimmable with dimmable drivers
- Field cuttable every 6" (Maximum run is 16ft.)
- Sold in 33 Rolls
- cULus certified for wet locations
- 3 years limited warranty

## APPLICATIONS

- Architectural lighting
- Signage
- Landscape lighting
- Exterior/interior commercial

## SPECIFICATIONS

<b>Product Code</b>		ES-LS2835-30-WH-24-4FT
<b>Electrical</b>	Input Voltage	24V DC
	Power Consumption	5.8W/Ft
<b>Specs</b>	Colour Temperature	3000K
	CRI	90+
	Efficacy	105LM/W
	Luminous Flux	610LM/FT
	Dimmable	Yes
	Beam Angle	30°
<b>LED</b>	Type	SMD2835
	Life Span	30,000 Hours
	Spacing	N/A
	# per foot (304mm)	14
<b>Design</b>	Dimensions (Inches)	5/16" x 9/16"
	Dimensions (Millimeters)	8 x 15mm
	Max Single Run Length	N/A
	Custom Cuttable	N/A
	Approved Location	Indoor/Outdoor
	Mounting	Ceiling, floor
<b>Warranty</b>	6 years	
<b>Approvals</b>	cULus for wet locations	

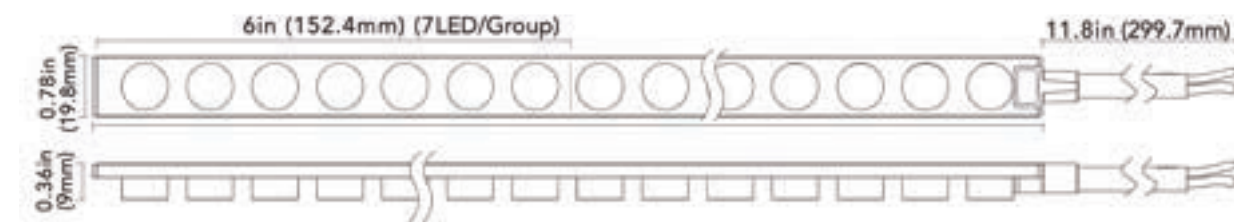

## ACCESSORIES



**NFLX-GLUE**  
Glue



**ES-EC**  
End Cap

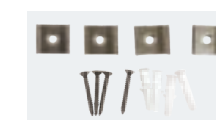

**ES-MC**  
Mounting Clips  
(4pcs/bag)



**ES-WB**  
Wall Washer Wall Bracket Set



**ES-PFC-6FT**  
Power Feed Connector



**ES-JC-6IN 6IN,**  
**ES-JC-12IN 12IN,**  
**ES-JC-3FT 3FT,**  
**ES-JC-6FT 6FT**  
Jumper Cable

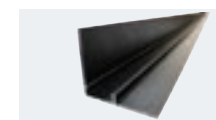

**ES-EXT**  
ES-EXT Aluminum extrusion (8FT), anodized black, for ceiling or floor mounting. For wall mounting, please see the wall mounting brackets.



Three wall mounting brackets available to enhance the wall washing effect:  
**ES-MB-2IN 2IN**  
**ES-MB-4IN 4IN**  
**ES-MB-6IN 6IN**  
Wall Mounting Bracket

## INDOOR/OUTDOOR DIMMABLE DRIVERS

**TRE24L40DC**  
6.77" x 2.67" x 1.26" (171 x 68 x 32mm)

**TRE24L96DC**  
6.77" x 2.67" x 1.26" (171 x 68 x 32mm)

## NON DIMMABLE DRIVERS

**LEDDR-24-120W (Indoor/Outdoor)**  
120W hardwire  
Input: 100 - 240V AC  
Output: 24V DC  
10" x 3 3/8" x 3 3/16" (254 x 85.7 x 80.9mm)



# Under Cabinet Lighting

## UNDER CABINET LIGHTING

# 5CCT LED Task Bar

For those seeking high performance LED under cabinet lighting fixture, the 5CCT LED Task Bar offers customizable lighting, true color representation, energy efficiency, easy installation, versatility, and durability.



### FEATURES

- Available in white finish
- Life: 35,000 Hours
- 120V Plug and cord and hardwire power cord available (sold separately)
- Easy installation
- 5 position switch for colour temperature adjustment
- Slim profile
- Dimmable with TRIAC dimmers
- Linkable up to 200W using end to end connectors or jumper cords
- Jumper cords available (sold separately)

### APPLICATIONS

- Under cabinet task light
- Over cabinet accent light
- Display cases and exhibits
- Merchandising
- Wall units and bars
- Office work stations

### SPECIFICATIONS

		Size 1	Size 2	Size 3	Size 4	Size 5	Size 6
<b>Product code</b>	LEDLB-5CCT-XX	10 Inches	12 Inches	18 Inches	24 Inches	36 Inches	48 Inches
<b>Electrical</b>	Input Voltage	120V AC					
	Power Consumption	3.5W	5W	8W	12W	16W	20W
	Max Wattage per run	200W					
<b>Specs</b>	Colour Temperature	2700/3000/3500/4000/5000K					
	CRI	90					
	Lumen Output	290	443-541	652-771	966-1134	1199-1393	1599-1892
	Efficacy (Lm/W)	82.8	98.4	88.75	82.5	81.25	87.5
	Dimmable	Yes, with TRIAC dimmers					
	Beam Angle	110°					
	<b>LED</b>	Type	SMD2835				
	Life Span	35,000 Hours					
	Spacing	N/A					
	# per foot / unit	N/A					
<b>Design</b>	Dimensions Inches (l;h;w)	9 3/4; 1 5/16; 13/16"	12 3/8; 1 5/16; 13/16"	17 1/2; 1 5/16; 13/16"	22 5/8; 1 5/16; 13/16"	34 7/16; 1 5/16; 13/16"	46 1/4; 1 5/16; 13/16"
	Dimensions mm (l/h/w)	247 / 33 / 20mm	315 / 33 / 20mm	445 / 33 / 20mm	575 / 33 / 20mm	875 / 33 / 20mm	1175 / 33 / 20mm
	Finish Colour / trims	White					
	Product Material	Aluminum and acrylic					
	Max Single Run Length	40Ft					
	Custom Cuttable	N/A					
	Operating Temperature	-20°C to 40°C					
	Approved Location	Damp					
Mounting	Via included brackets						
<b>Warranty</b>		3 years					
<b>Approvals</b>		cETLus for indoor use					

NOTE: Only LEDLB-5CCT-18, LEDLB-5CCT-24, LEDLB-5CCT-36, and LEDLB-5CCT-48 have on/off switch.



**NSL**  
NATIONAL SPECIALTY LIGHTING

### DIAGRAM

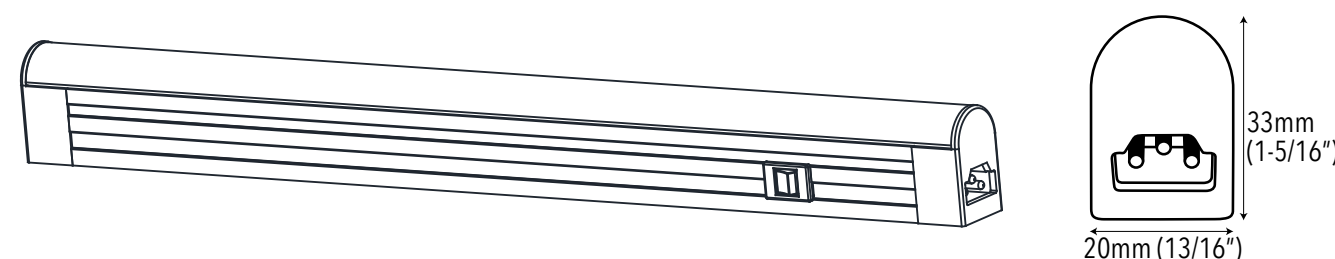

### PRODUCT CODES

LEDLB - 5CCT - XX

### SIZE

10, 12, 18, 24, 36, 48

### ACCESSORIES



**LEDLB-J-12**  
12" Jumper Cable



**LTSPRO-PC-72**  
72" power cord and plug



**LTSPRO-JB**  
Hardwire junction box With ON/OFF switch

**LEDLB-J-18**  
18" Jumper Cable

**LTSPRO-HW-72**  
72" power cord for hardwire

**LEDLB-J-24**  
24" Jumper Cable

**LEDLB-J-32**  
32" Jumper Cable

# Gen II LED Hard Strip

Gen II LED Hard Strip is a new and improved energy efficient linkable strip, that provides a smooth, even lighting, eliminating any hot spots. Encased in an aluminum casing, the LED's are cool to the touch and provide 120° beam spread.



## FEATURES

- 50,000 hours life between two strips
- Use high brightness 0.5W Epistar LEDs as lighting source
- Even light distribution with 120° viewing angle
- Available in 4 sizes
- Convenient connector
- Diffused frosted lens to reduce glare

## APPLICATIONS

- Under counter
- Display cases
- Cabinet interiors
- Work stations
- Interior decorative lighting

## SPECIFICATIONS

		Size 1	Size 2	Size 3	Size 4
<b>Product code</b>	LV-HS-PD20-24V-YY-XX	30	50	100	120
<b>Electrical</b>	Input Voltage	24V DC			
	Power Consumption	4W	7W	13W	16W
<b>Specs</b>	Colour Temp: Neutral White	4200K +/- 200K			
	Colour Temp: Warm White	3000K +/- 200K			
	Lumens (LM): Neutral White	400	664	1066	1150
	Lumens (LM): Warm White	380	621	1036	1100
	Viewing Angle	120°			
<b>LED</b>	Life Span	50,000 Hours			
	Qty. per strip	36	60	132	156
<b>Design</b>	Size	11.8" (300mm)	19.7" (500mm)	39.4" (1000mm)	47.3" (1200mm)
	Product Material	Aluminum			
	Operating Temperature	-35°C to 50°C			
	Mounting	2 pieces of 0° mounting clips and one end cap			
<b>Warranty</b>	3 years limited				
<b>Approvals</b>	cETLus for indoor use				

NOTE: Each Hard Strip bar ships with 2pcs of 0° mounting clips and one end cap.

## MOUNTING OPTIONS

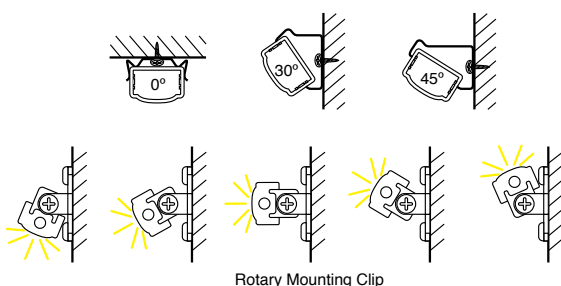

## PRODUCT CODES

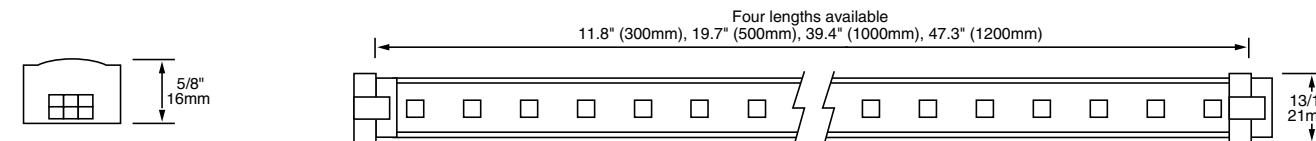
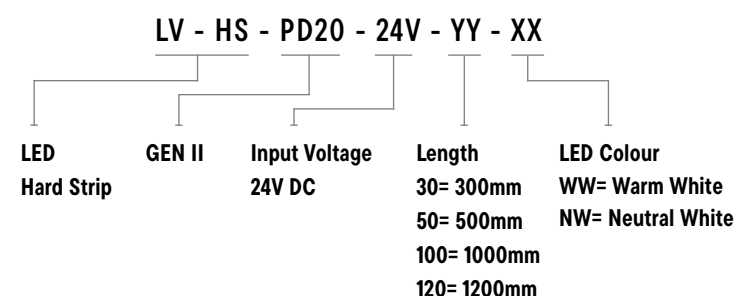

## NON DIMMABLE

### NON DIMMABLE

**LEDDR-24-120W**  
Indoor/Outdoor driver  
Max. recommended load 90W per single tap, 120W combined two secondary taps.  
120W hardwire  
Input: 100 - 240V AC  
Output: 24V DC  
10" x 3 3/8" x 3 3/16" (254 x 85.7 x 80.9mm)

## INDOOR/OUTDOOR DIMMABLE DRIVERS

**TRE24L40DC**  
Max recommended load 36W,  
min. 8W LED Hard Strip  
6.77" x 2.67" x 1.26" (171 x 68 x 32mm)

**TRE24L96DC**  
Max recommended load 90W,  
min. 8W LED Hard Strip  
6.77" x 2.67" x 1.26" (171 x 68 x 32mm)

## ACCESSORIES

<b>LV-HS-PD20-PF1-12</b> 12" Power Feed for LED Hard Strip single colour, Bar – DC plug power supply	<b>LV-HS-PD20-PF1-39</b> 39" Power Feed for LED Hard Strip single colour, Bar – DC plug power supply	<b>LV-HS-PD20-PF1-HW</b> 39" Power Feed for LED Hard Strip single colour, Bar – Hard wire power supply	<b>LV-HS-PD20-PC1-12</b> 12" Power Connector for LED Hard Strip single colour, Bar – Bar	<b>LV-HS-PD20-PC1-39</b> 39" Power Connector for LED Hard Strip single colour, Bar – Bar
<b>LV-HS-PD20-PC1-3</b> 3" Power Connector for LED Hard Strip Single Colour, Bar – Bar	<b>LV-HS-CN-3DC</b> Connector for Hard Strip, with 12" wire lead and 3 DC connectors	<b>LV-HS-EC</b> End Cap for LED Hard Strip	<b>LV-HS-MC0</b> Mounting clip (2pk)	<b>LV-HS-MC30</b> Mounting clip 30° (2pk)
	<b>LV-HS-CN-2DC</b> Connector for Hard Strip, with 12" wire lead and 2 DC connectors			
<b>LV-HS-MC45</b> Mounting clip 45° (2pk)	<b>LV-HS-MCTR</b> Rotary Mounting clip (2pk)			

UNDER CABINET LIGHTING

# Gen II 3-Colour Change LED Task Star

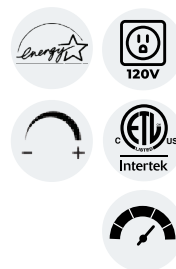

Craft the perfect ambiance with Gen II LED Task Star's color temperature control, easy-to-install features, and a 5-year warranty.

FEATURES

- NEW: 1/2" Knockouts for easy installation
- 3 position switch for colour temperature adjustment (3000K/4000K/5000K)
- Available in 5 lengths for multiple applications
- Dimmable with most ELV dimmers.
- Captive mounting screws
- Continuous dimming with a 5%–100% dimming range
- Easy installation
- High Low switch
- 5 years limited warranty
- Available in white, black, bronze and aluminum finish

APPLICATIONS

- Under counter
- Display cases
- Cabinet interiors
- Work stations
- Interior decorative lighting

SPECIFICATIONS						
		Size 1	Size 2	Size 3	Size 4	Size 5
<b>Product code</b>	LTS-II-Y-HW/XX	1	2	3	4	5
<b>Electrical</b>	Input Voltage	120V AC				
	Power Consumption	5W	10W	15W	20W	25W
<b>Specs</b>	Colour Temp	3000/4000/5000K				
	CRI	90+				
	Lumens (Output)	310LM	650LM	1000LM	1300LM	1500LM
	Dimmable	Most ELV dimmers - continous dimming with a 5%-10% dimming range				
<b>LED</b>	Type	0.5W Epistar				
	Life Span	50,000 Hours				
<b>Design</b>	Dimensions (Inches)	9.5 x 4.47 x 1.54"	17.5 x 4.47 x 1.54"	26 x 4.47 x 1.54"	34.5 x 4.47 x 1.54"	43 x 4.47 x 1.54"
	Dimensions (Millimeters)	240 x 113.5 x 39mm	443.5 x 113.5 x 39mm	659.2 x 113.5 x 39	874.9 x 113.5 x 39mm	1090 x 113.5 x 39mm
	Lens	Frosted glass				
	Finish	BK-Black, BZ-Bronze, AL-Aluminum, WH-White				
	Mounting	N/A				
<b>Warranty</b>		5 years limited				
<b>Approvals</b>		cETLus and Energy Star				

PRODUCT CODES

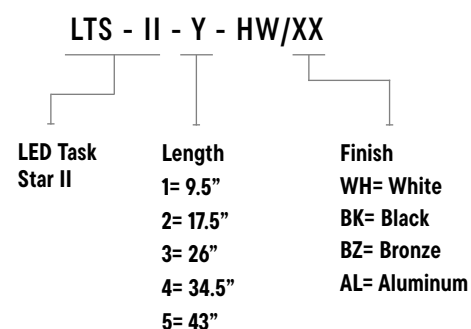

**NSL**  
NATIONAL SPECIALTY LIGHTING

DIAGRAM

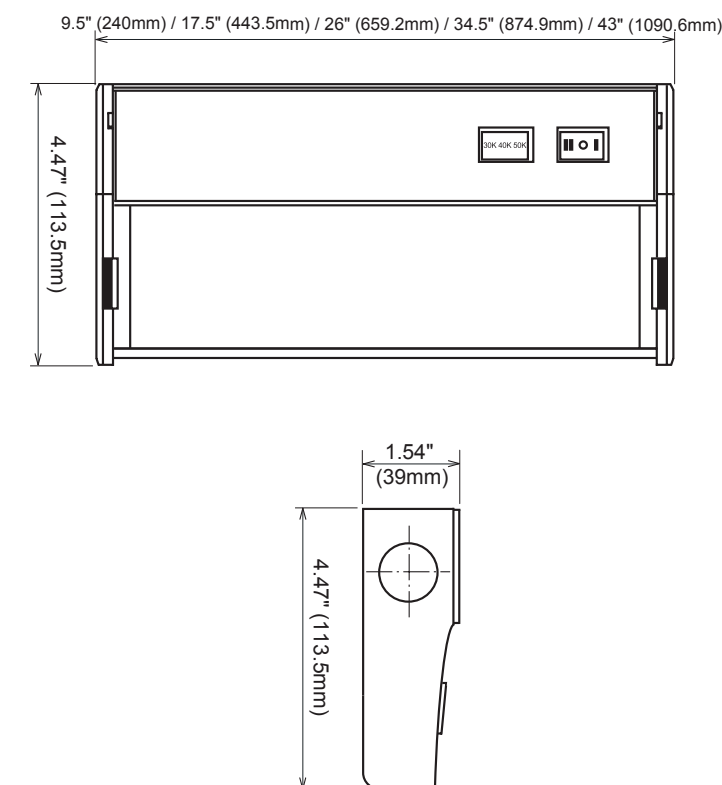



# LED Task Star PRO

LTSPRO is constructed with aluminum housing and a matte polycarbonate diffuser. This sleek fixture features edge lit technology which means no hot spots on the polished marble or granite counter top.



## FEATURES

- Long lasting 50,000 hours life
- Comes with High / Low Switch
- Low power consumption
- Edge Lit technology eliminates hot spots
- Fast and easy installation – quick connects, captive mounting holes
- Comes with cord and plug as well as knockouts for hardwire
- 3/8" connector provided
- Shallow profile conceals fixture
- Linkable up to 400 watts. Each fixture ships with 8" jumper cable and end-to-end connector
- cETLus and Energy Star listed
- 3 years limited warranty

## APPLICATIONS

- Under cabinet task light
- Over cabinet accent light
- Display cases and exhibits
- Merchandising
- Indirect accent light
- Wall units and bars

SPECIFICATIONS							
Product Code	LTSPRO- XX-YY	Size 1	Size 2	Size 3	Size 4	Size 5	Size 5
Electrical	Input Voltage	120V AC					
	Power Consumption	5W	5W	8W	12W	16W	20W
Specs	Colour Temp	2700/3300/4000K					
	CRI	90+					
	Lumens (Output)	200LM	300LM	450LM	700LM	900LM	1000LM
	Dimmable	Yes					
LED	Type	Epistar					
	Life Span	50,000 Hours					
Design	Dimensions (Inches)	9 x 3.5 x 1"	12 x 3.5 x 1"	18 x 3.5 x 1"	24 x 3.5 x 1"	32 x 3.5 x 1"	40 x 3.5 x 1"
	Dimensions (MM)	22.9 x 8.9 x 2.5mm	30.5 x 8.9 x 2.5mm	45.7 x 8.9 x 2.5mm	61 x 8.9 x 2.5mm	81.3 x 8.9 x 2.5mm	101.6 x 8.9 x 2.5mm
	Lens	Matte white polycarbonate					
	Body	Extruded aluminum housing					
	Finish	BK-Black, BZ-Bronze, SN-Satin Nickel, WH-White					
Warranty		3 years limited					
Approvals		cETLus and Energy Star					

## PRODUCT CODES

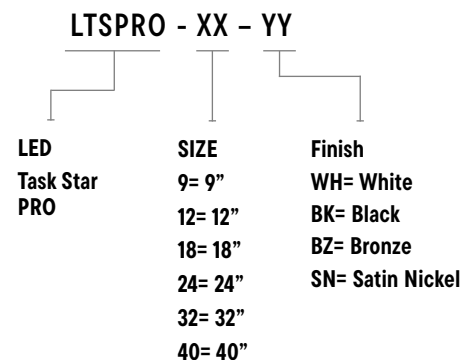

## DIAGRAM

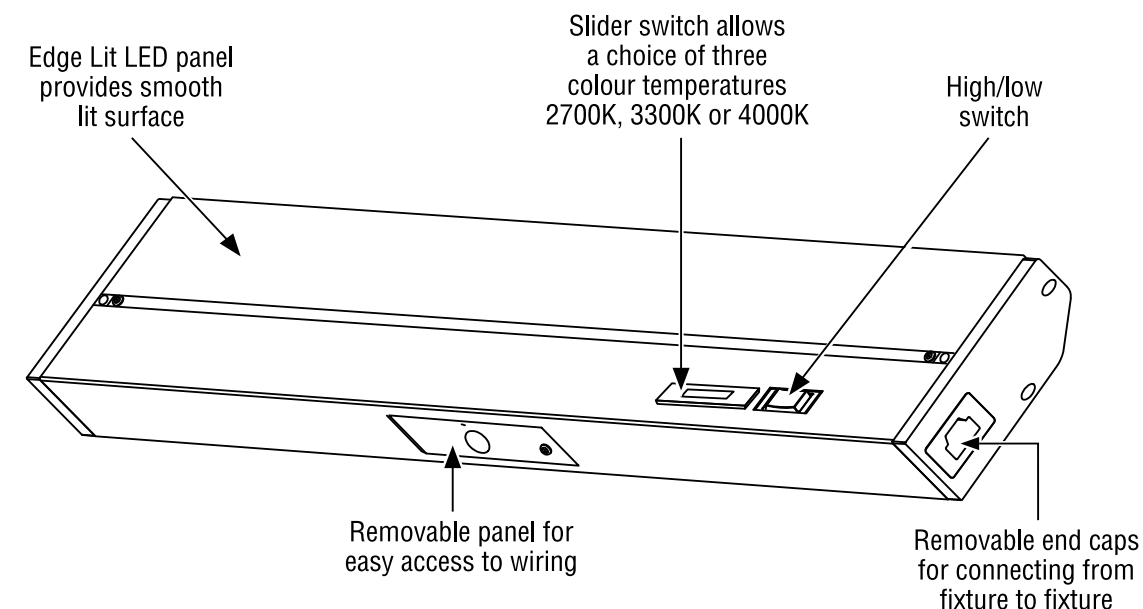

## ACCESSORIES

- LTSPRO-J-12\***  
12" jumper cable
- LTSPRO-J-18\***  
18" jumper cable
- LTSPRO-J-24\***  
24" jumper cable
- LTSPRO-J-32\***  
32" jumper cable
- LTSPRO-PC-72\***  
72" replacement power cord and plug
- LTSPRO-JB**  
Hardwire junction box for LTSPRO fixtures - allows for direct wiring installation,
- RC-01**  
3/8" Romex connector

## REPLACEMENT PARTS

- LTSPRO-SW-BK**  
CCT Slider Switch Cover, Black
- LTSPRO-SW-WH**  
CCT Slider Switch Cover, White

# LED Edgelit Puck Lights

The Edge Lit Puck Lights are sleek and powerful surface mount lighting fixtures, combining the easy installation with high performance LED's. Featuring strong internal magnets, they can be installed on metal surfaces, without screws or mounting holes.



## FEATURES

- 30,000 hours life
- Edgelit design with smooth light output
- Safe 24V low voltage operation
- Operating temperature: -30°C to 40°C
- Durable die-cast aluminum housing suitable for dry location
- Strong magnet and stamped steel plate for surface mounting
- 72 inch pre-installed lead wire
- 3-year limited warranty

## APPLICATIONS

- Under cabinets
- Over cabinets
- Indirect lighting
- Display cases
- Furniture
- Shelf lighting

## SPECIFICATIONS

Product Code		EPL - SR - WW - XX (ROUND)	EPL - SS - WW - XX (SQUARE)
Electrical	Input Voltage	24V DC	
	Power Consumption	4W	
Specs	Colour Temperature	3000K	
	CRI	90+	
	Lumens	200LM	
	Efficacy (LM/W)	50	
	Dimmable	Yes	
	Beam Angle	24/36/60° (Replacable)	
LED	Type	5630 SMD LEDs	
	Life Span	30,000 Hours	
Design	Dimensions (Inches)	3 x 0.5"	3 x 0.5"
	Dimensions (Millimeters)	76 x 12.7mm	76 x 12.7mm
	Finish	White, Black, Bronze	
	Material	Die-cast aluminum	
	Operating Temperature	-20 to 40°C	
	Approved Location	Indoor	
Mounting	Surface mount		
Warranty	3 years		
Approvals	cETLus		

## PRODUCT CODE

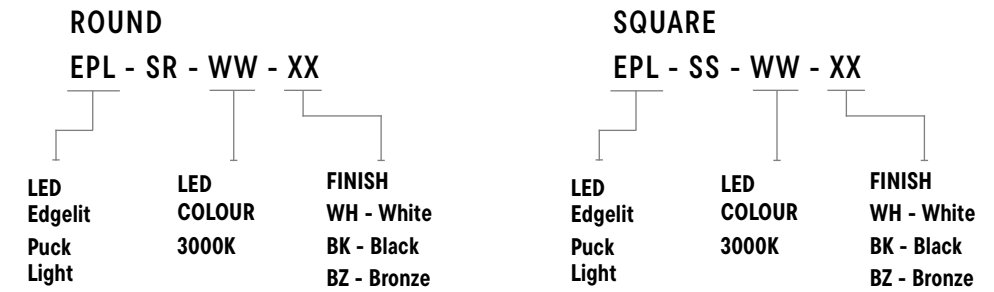

## DIAGRAM

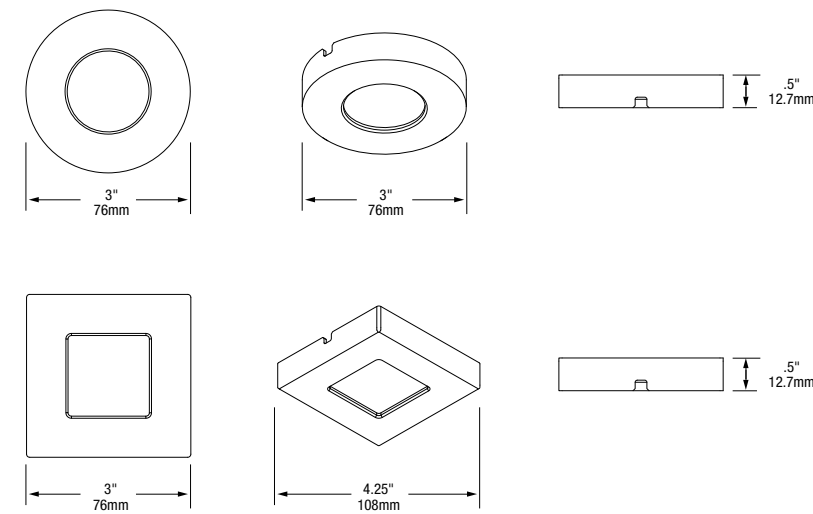

## ACCESSORIES



### LMSII-001

Terminal block and junction box for connection to additional lengths of power cable if needed.

## DIMMABLE DRIVERS

### TRE24L40DC

Max recommended load 36W or 9 Edge Lit Puck Lights, min 8W or 2 Edge Lit Puck Lights 6.77" x 2.67" x 1.26" (171 x 68 x 32mm)

### TRE24L96DC

Max recommended load 92W or 23 Edge Lit Puck Lights, min 8W or 2 Edge Lit Puck Lights 6.77" x 2.67" x 1.26" (171 x 68 x 32mm)

## NON-DIMMABLE DRIVERS

### LEDDR-24-120W

Indoor/Outdoor driver Max. recommended load 96W or 24 Edge Lit Puck Lights per single tap, 120W or 30 Edge Lit Puck Lights combined two secondary taps. 120W hardware Input: 100 - 240V AC Output: 24V DC 10" x 3 3/8" x 3 3/16" (254 x 85.7 x 80.9mm)



# Landscape Lighting

# Uplight (Wattage Adjustable)

Engineered for durability and flexibility, this LED Uplight achieves up to 900 lumens of brightness with adjustable wattage, complemented by a choice of three beam spreads.



## FEATURES

- Adjustable wattage control
- High lumen output
- Durable die-cast aluminum
- Versatile beam spread
- Sleek black finish
- Wide voltage compatibility
- Warm light temperature
- Easy installation design
- Weather-resistant coating
- Long-lasting 15 years warranty

## APPLICATIONS

- Garden lighting
- Facade lighting
- Pathway safety
- Security lighting
- Sign lighting
- Patio ambiance



SPECIFICATIONS		
<b>Product Code</b>	UP-01-12V-BLK	
<b>Electrical</b>	Input Voltage	9-17V AC/DC
	Power Consumption	0-12W (Adjustable)
<b>Specs</b>	Colour Temperature	3000K
	CRI	85
	Lumen Output	900LM Max.
	Efficacy (LM/W)	83
	Dimmable	N/A
	Beam Angle	24/36/60° (Replacable)
<b>LED</b>	Life Span	50,000 Hours
<b>Design</b>	Dimensions (Inches)	6.4 x 6.7 x 2.9"
	Dimensions (Millimeters)	161 x 177 x 73mm
	Finish	Black powder coating
	Material	Die-cast aluminum
	Operating Temperature	-20 to 40°C
	Approved Location	Outdoor
	Mounting	Via Stake
<b>Warranty</b>	15 years	
<b>Approvals</b>	cETLus	

## DIAGRAM

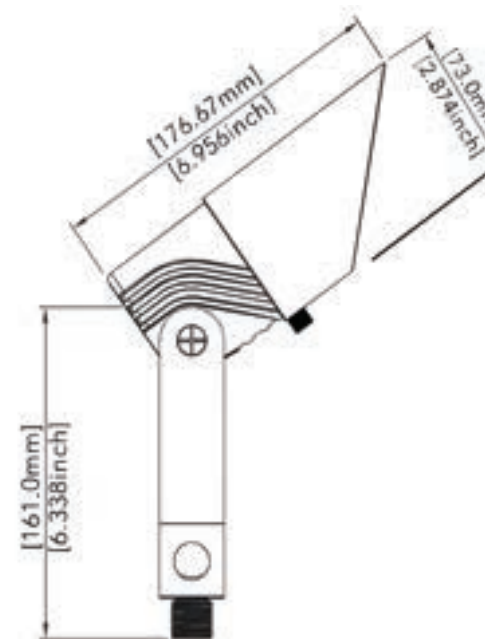

## ACCESSORIES

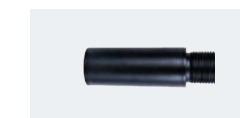

**ACC-3R-BLK**  
3 Inch Riser Black

- Male female end
- ½ inch NPSM thread
- Cast brass
- Black Finish



**ACC-7R-BLK**  
7 Inch Riser Black

- 1 Male and 1 Female end
- ½ inch NPSM thread
- Cast brass
- Black Finish

# Uplight (RGBW)

Elevate your ambiance with the RGBW Uplight, capable of shining in a myriad of colors at up to 500 lumens, featuring smart app connectivity for easy adjustments, and built with a robust die-cast aluminum body.



## FEATURES

- Adjustable wattage control
- Multiple RGBW colors
- 24/36/60° beam angles
- Durable aluminum construction
- Smart app control
- WIFI/Bluetooth enabled
- 9-17V AC/DC compatible
- Sleek black finish
- Long-lasting 15 years warranty

## APPLICATIONS

- Accent lighting
- Path illumination
- Garden highlights
- Security lights
- Art spotlights
- Event lighting



## SPECIFICATIONS

<b>Product Code</b>	UP-02-12V-BLK	
<b>Electrical</b>	Input Voltage	9-17V AC/DC
	Power Consumption	0-8W (Adjustable)
<b>Specs</b>	Colour Temperature	2700K-6000K
	CRI	85
	Lumen Output	500LM Max.
	Efficacy (LM/W)	70
	Dimmable	N/A
	Beam Angle	24/36/60° (Replacable)
<b>LED</b>	Life Span	50,000 Hours
<b>Design</b>	Dimensions (Inches)	6.4 x 6.7 x 2.9"
	Dimensions (Millimeters)	161 x 177 x 73mm
	Finish	Black powder coating
	Material	Die-cast aluminum
	Operating Temperature	-20 to 40°C
	Approved Location	Outdoor
	Mounting	Via Stake
<b>Warranty</b>	15 years	
<b>Approvals</b>	cETLus	

## DIAGRAM

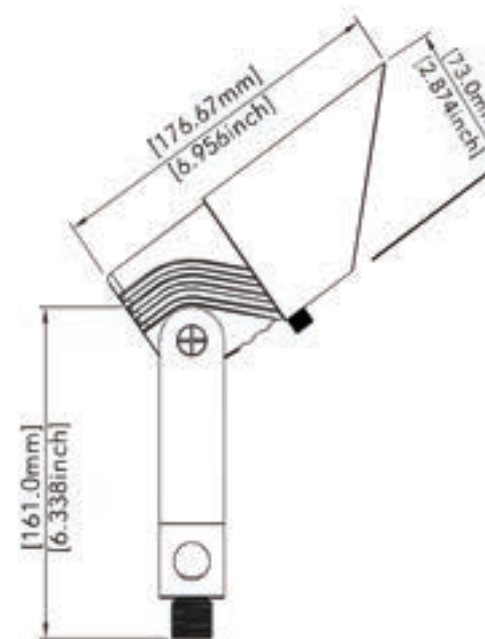

## ACCESSORIES



**ACC-3R-BLK**  
3 Inch Riser Black

- Male female end
- ½ inch NPSM thread
- Cast brass
- Black Finish



**ACC-7R-BLK**  
7 Inch Riser Black

- 1 Male and 1 Female end
- ½ inch NPSM thread
- Cast brass
- Black Finish

# 12V Mini Flood Light

This compact yet powerful 12V Mini Flood light, with a customizable wattage between 1 and 5 watts, provides a luminous output of 80-400 lumens, encased in a durable cast brass housing.



## FEATURES

- Adjustable wattage control
- 80-400 lumen output
- Integrated 12V LED
- Cast brass housing
- 3000K warm light
- Black or bronze finish
- Spike mounting option
- Wide beam angle
- Long-lasting 15 years warranty
- Smart control compatibility

## APPLICATIONS

- Path illumination
- Outdoor accents
- Security lighting
- Architectural highlights
- Event ambiance
- Patio glow



## SPECIFICATIONS

<b>Product Code</b>	FL-01-12V-BLK	
<b>Electrical</b>	Input Voltage	12V AC/DC
	Power Consumption	1-5W
<b>Specs</b>	Colour Temperature	3000K
	CRI	85
	Lumen Output	400LM
	Efficacy (LM/W)	80
	Dimmable	N/A
	Beam Angle	120°
<b>LED</b>	Life Span	50,000 Hours
<b>Design</b>	Dimensions (Inches)	4 x 3.9 x 2.5"
	Dimensions (Millimeters)	101.5 x 100 x 63mm
	Finish	Black
	Material	Solid Brass Casting
	Operating Temperature	-20 to 40°C
	Approved Location	Outdoor
	Mounting	Via Stake
<b>Warranty</b>	15 years	
<b>Approvals</b>	cETLus	

## DIAGRAM

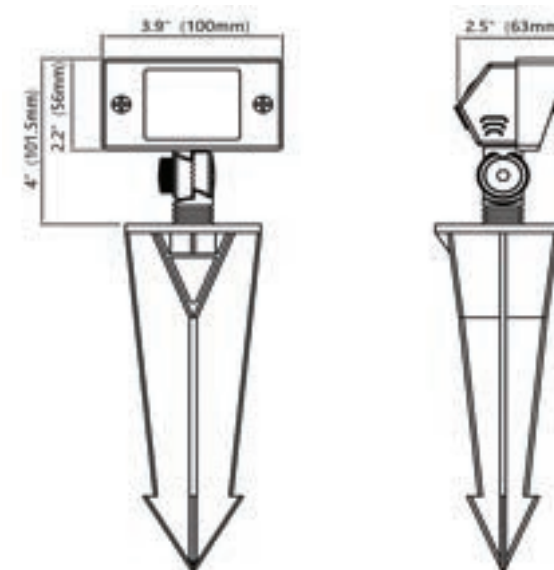

## ACCESSORIES

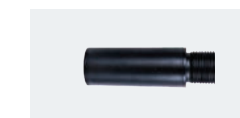

**ACC-3R-BLK**  
3 Inch Riser Black

- Male female end
- ½ inch NPSM thread
- Cast brass
- Black Finish



**ACC-7R-BLK**  
7 Inch Riser Black

- 1 Male and 1 Female end
- ½ inch NPSM thread
- Cast brass
- Black Finish

# 120V Mini Flood Light (CCT)

Achieve perfect outdoor lighting for any occasion with CCT Adjust Mini Flood Lights, featuring adjustable CCTs for versatile illumination. Their compact size and high efficiency make them a smart choice for diverse landscape applications.

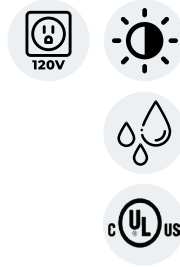

## FEATURES

- Adjustable CCT (3000K/4000K/5000K)
- High lumen output
- Easy installation
- Wide beam angle
- Long lifespan (50,000 hours)
- Instant start, no flicker
- Wattage options (15W, 30W, 50W)
- Wet location rated
- 5 years warranty

## APPLICATIONS

- Facade accenting
- Garden highlights
- Outdoor art display
- Parking areas
- Entryway illumination
- Commercial exteriors

## SPECIFICATIONS

Product Code	FL-15-CT	FL-30-CT	FL-50-CT	
<b>Electrical</b>	Input Voltage	100 -277V AC		
	Power Consumption	15W	30W	50W
<b>Specs</b>	Colour Temperature	3000/4000/5000K		
	CRI	80+		
	Lumen Output	3000K: 1725-1950LM	3000K: 3450-3900LM	3000K: 5750-6500LM
		4000K: 2025-2250LM	4000K: 4050-4500LM	4000K: 6750-7500LM
		5000K: 1875-2100LM	5000K: 3750-4200LM	5000K: 6250-7000LM
	Efficacy (LM/W)	N/A		
Dimmable	N/A			
Beam Angle	150° x 120° (7H6V)			
<b>LED</b>	Type	SMD3030 (1W)		
	Life Span	50,000 Hours		
<b>Design</b>	Dimensions (Inches)	6 5/8 x 8 x 1 3/4"	6 5/8 x 8 x 1 3/4"	7 5/16 x 9 7/16 x 1 15/16"
	Dimensions (Millimeters)	168.3 x 204 x 43.7 mm	168.3 x 204 x 43.7 mm	201 x 239 x 49 mm
	Finish	Black		
	Material	N/A		
	Operating Temperature	-20 to 50°C		
	Approved Location	Wet		
Mounting	Via Stake			
<b>Warranty</b>	5 years			
<b>Approvals</b>	cULus listed for wet locations			

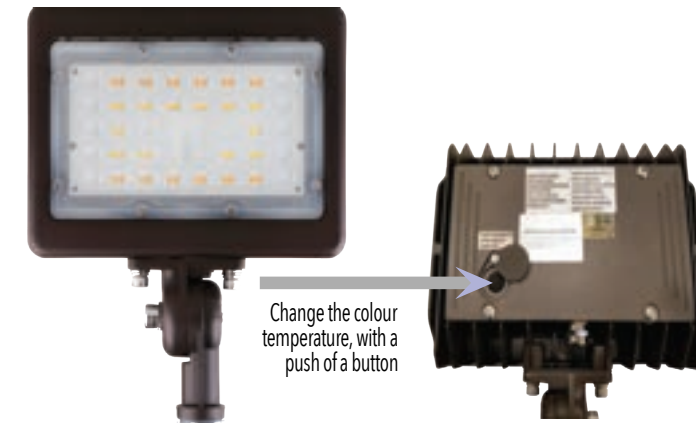

Change the colour temperature, with a push of a button

## DIAGRAM

### 15W and 30W

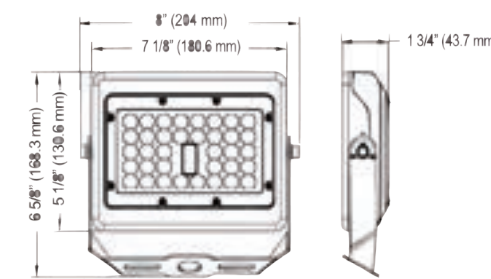

### 50W

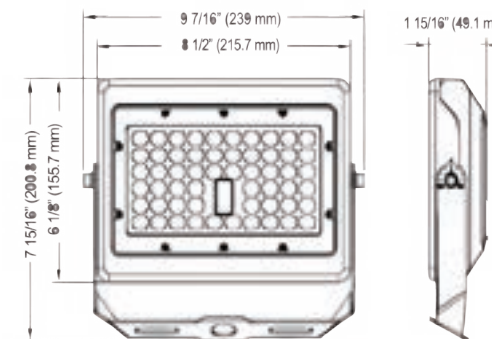

## MOUNTING ACCESSORIES

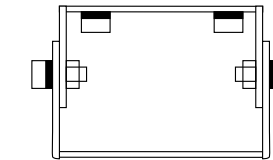

**FL-TR**  
Trunnion mount bracket  
To use for wall and ground mount

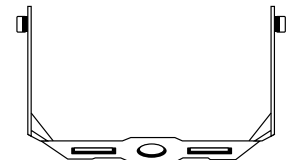

**FL-Y-15/30/50**  
Yoke mount bracket  
To use for wall and ground mount



**FL-SH-15/30/50**  
Glare shield

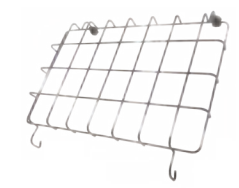

**FL-WG-15/30/50**  
Wire guard

## ACCESSORIES

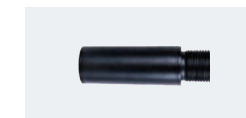

**ACC-3R-BLK**  
3 Inch Riser Black



**ACC-7R-BLK**  
7 Inch Riser Black

- Male female end
- 1/2 inch NPSM thread
- Cast brass
- Black Finish

- 1 Male and 1 Female end
- 1/2 inch NPSM thread
- Cast brass
- Black Finish

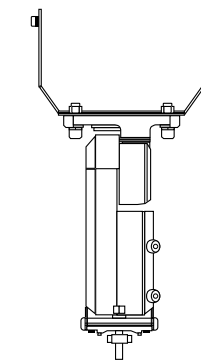

**FL-ADM-15/30/50**  
Universal mount bracket  
For use on poles

# Modern Pathway Light

Designed for the modern landscape, this L-shaped Pathway Light offers an adjustable light output of 80-240 lumens and a warm 3000K temperature, creating a welcoming atmosphere for any outdoor setting.

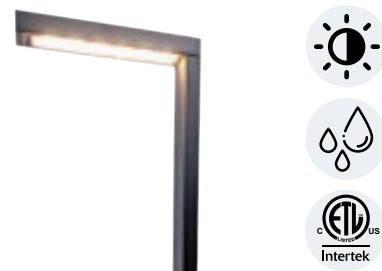

## FEATURES

- L-shaped contemporary design
- Adjustable 1-3W wattage
- Integrated 9-17V LED
- Warm 3000K temperature
- Durable cast aluminum
- Frosted lens diffusion
- Easy spike mounting
- 18/2 wire pigtail
- Full/half light mode
- Serviceable LED module
- Wet location listed
- Long-lasting 15 years warranty

## APPLICATIONS

- Pathway illumination
- Garden lighting
- Outdoor accent
- Entryway paths
- Architectural highlights
- Safety lighting

## SPECIFICATIONS

<b>Product Code</b>	WF-01-12V-BLK	
<b>Electrical</b>	Input Voltage	9-17V AC/DC
	Power Consumption	1-3W
<b>Specs</b>	Colour Temperature	3000K
	CRI	85
	Lumen Output	80-240LM
	Efficacy (LM/W)	77
	Dimmable	N/A
<b>LED</b>	Beam Angle	150° (Replacable)
	Life Span	50,000 Hours
<b>Design</b>	Dimensions (Inches)	21 1/4 x 6 1/8 x 7/8"
	Dimensions (Millimeters)	540.2 x 154 x 22mm
	Finish	Black
	Material	Aluminum
	Operating Temperature	-40 to 40°C
	Approved Location	Outdoor
	Mounting	Via Stake
<b>Warranty</b>	15 years	
<b>Approvals</b>	cETLus	



## DIAGRAM

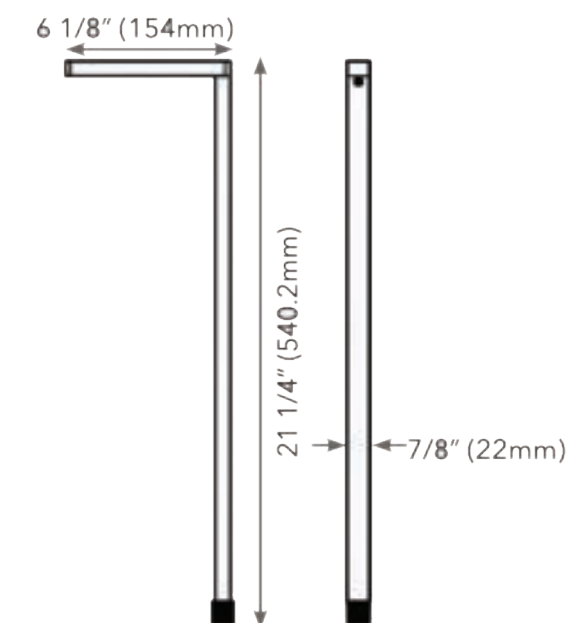



# Round Tea-Hat Pathway Light

The Round Tea-Hat Light redefines pathway illumination with its unique round hat design, offering an energy-efficient solution to brighten outdoor settings, backed by a durable construction..



## FEATURES

- Wattage fine-tuning
- Broad lumen range
- Low-voltage efficiency
- Warm color temperature
- Durable cast aluminum construction
- Hastle-free installation
- Spike-mounted for stability
- Sleek black finish
- Easy-connect 18/2 wire pigtail
- Long-lasting 15 years warranty

## APPLICATIONS

- Pathway lighting
- Landscape accent
- Garden paths
- Entrance lighting
- Recreational areas

## SPECIFICATIONS

<b>Product Code</b>	WF-03-12V-BLK	
<b>Electrical</b>	Input Voltage	9-17V AC/DC
	Power Consumption	1-3W
<b>Specs</b>	Colour Temperature	3000K
	CRI	85
	Lumen Output	80-240LM
	Efficacy (LM/W)	80
	Dimmable	N/A
	Beam Angle	150°
<b>LED</b>	Life Span	50,000 Hours
<b>Design</b>	Dimensions (Inches)	23 1/2 x 3 5/8 x 1"
	Dimensions (Millimeters)	597 x 93 x 26mm
	Finish	Black
	Material	Aluminum
	Operating Temperature	-40 to 40°C
	Approved Location	Outdoor
	Mounting	Via Stake
<b>Warranty</b>	15 years	
<b>Approvals</b>	cETLus	



## DIAGRAM

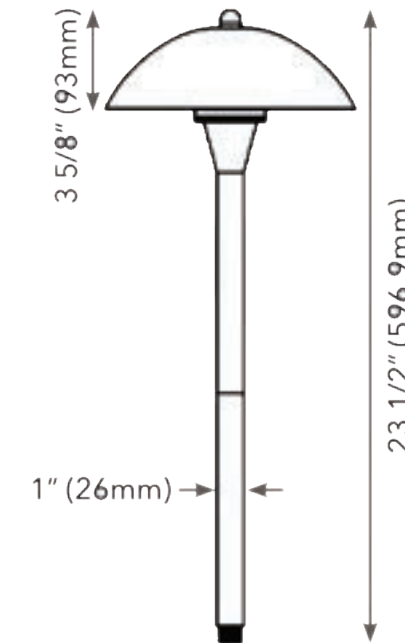

# Heavy Duty Classic Pathway Light

Upgrade outdoor spaces with the Classic Top Pathway Light, blending traditional aesthetics with energy-saving LED in a durable brass fixture.



## FEATURES

- Heavy cast brass construction
- Integrated 3000K LED chip
- 12V energy-saving operation
- Spike mounting simplicity
- Reliable 18/2 wire connection
- Classic design, modern tech
- Easy integration into landscapes
- Weather-resistant for outdoor use
- Long-lasting 15 years warranty

## APPLICATIONS

- Pathway lighting
- Garden enhancement
- Architectural accents
- Decorative outdoor
- Entrance highlighting
- Driveway borders

## SPECIFICATIONS

<b>Product Code</b>	WF-04-12V-BLK	
<b>Electrical</b>	Input Voltage	12V AC/DC
	Power Consumption	5W
<b>Specs</b>	Colour Temperature	3000K
	CRI	85
	Lumen Output	400LM
	Efficacy (LM/W)	80
	Dimmable	N/A
	Beam Angle	150°
<b>LED</b>	Life Span	50,000 Hours
<b>Design</b>	Dimensions (Inches)	14.96 x 6.6"
	Dimensions (Millimeters)	380 x 168mm
	Finish	Black
	Material	Die-cast brass
	Operating Temperature	-20 to 40°C
	Approved Location	Outdoor
	Mounting	Via Stake
<b>Warranty</b>	15 years	
<b>Approvals</b>	cETLus	



## DIAGRAM

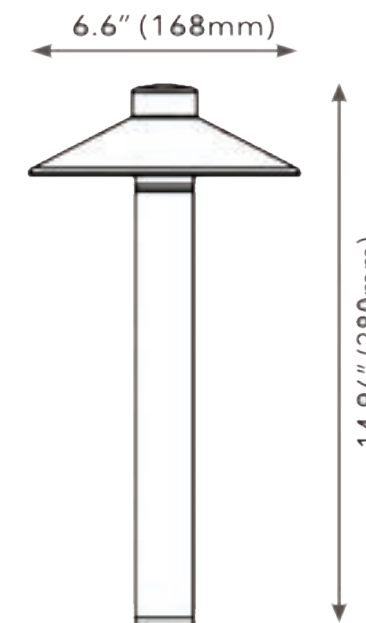

# Commercial Bollards

Engineered for outdoor resilience, bollard lights provide efficient, low-glare lighting, perfect for enhancing visibility and ambiance in landscape areas.



## FEATURES

- 3 base heights and 2 head options
- Input voltage range: 120-347V AC
- High efficiency: >92% power efficiency
- Dimmable: 0-10V dimming
- Surge protection: 4KV/6KV
- Tunable CCT: 3000/4000/5000K
- Wide beam angle: 110°x105°
- Durable build: IP65 rating, die-cast aluminum housing
- Long lifespan: >50,000 hours
- Certifications: ETL/DLC 5.1 premium
- Warranty: 5 years

## APPLICATIONS

- Pathways and walkways
- Gardens and flower beds
- Driveways and entrances
- Outdoor seating areas
- Pool decks and water features
- Perimeter and boundary lighting

## SPECIFICATIONS

Product Code	Head	WF-CB-MV-H-RMW (Round)		WF-CB-MV-H-FMW (Flat)
	Body	WF-CB-MV-BD1050	WF-CB-MV-BD670	WF-CB-MV-BD400
Electrical	Input Voltage	120-347V AC		
	Power Consumption	25/20/15/8W		
Specs	Colour Temperature	3000/4000/5000K (TUNABLE)		
	CRI	70+		
	Lumen Output	3,125/2,500/1,875/1,000LM		
	Efficacy	125 LM/W		
	Dimmable	0-10V		
LED	Beam Angle	110° x 105°		
	Type	3030		
Design	Life Span	>50,000 Hours		
	Dimensions (Inches)	R: H= 41.34"   F: H = 39.49"	R: H= 26.4"   F: H = 24.53"	R: H= 15.75"   F: H = 13.90"
		W= 5.91"		
	Dimensions (Millimeters)	R: H= 1050mm   F: H = 1003mm	R: H= 670mm   F: H = 623mm	R: H= 400mm   F: H = 353mm
		W= 150mm		
	Finish	Black		
	Material	Die-cast Aluminum		
Operating Temperature	-40°F to 104°F (-40°C to 40°C)			
Approved Location	Outdoor			
Mounting	N/A			
Warranty	5 years			



## DIAGRAM

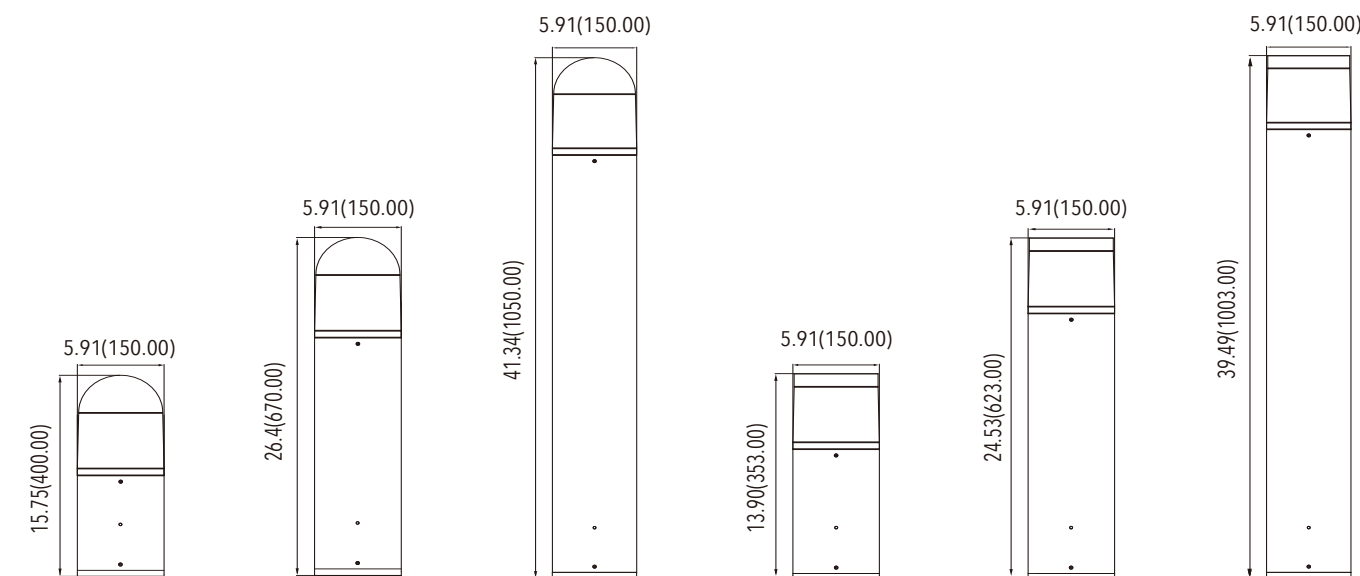

## ACCESSORIES



**WF-CB-SP**  
Surge Protector

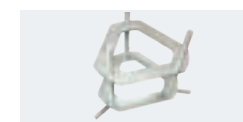

**WF-CB-MT**  
Anchor Bolt Carrier

NOTE: Fixture Head (Round or Flat) and Body are to be ordered separately.

# Surface Mount Deck/Riser Light

Create a welcoming atmosphere on decks and pathways with a light that adjusts to your preferences; easy installation for immediate impact.



## FEATURES

- Adjustable wattage from 1W to 3W with a dip switch
- 70° beam spread
- 85 CRI
- Warm glow (3000K)
- Sleek black finish
- Quick setup with 18/2 wire pigtail
- Cast aluminum housing
- Wet location listed
- Long-lasting 15 years warranty

## APPLICATIONS

- Pathway illumination
- Deck lighting
- Step safety
- Garden ambiance
- Entrance highlighting
- Fence lighting



## SPECIFICATIONS

<b>Product Code</b>	WF-02-12V-BLK	
<b>Electrical</b>	Input Voltage	12/24V AC/DC
	Power Consumption	0-3W (Adjustable)
<b>Specs</b>	Colour Temperature	3000K
	CRI	85
	Lumen Output	60-180LM
	Efficacy (LM/W)	60
	Dimmable	N/A
	Beam Angle	70°
<b>LED</b>	Life Span	50,000 Hours
<b>Design</b>	Dimensions (Inches)	4 x 2 5/8"
	Dimensions (Millimeters)	101.6 x 66.67 mm
	Finish	Black
	Material	Aluminum
	Operating Temperature	-40 to 40°C
	Approved Location	Outdoor
	Mounting	Via Stake
<b>Warranty</b>	15 years	
<b>Approvals</b>	cETLus	

## DIAGRAM

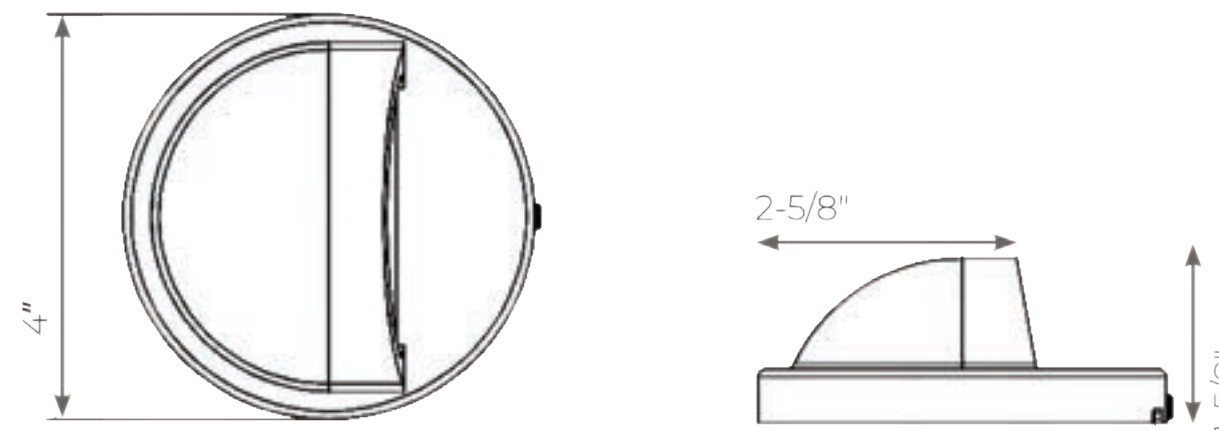

# Outdoor Wall Sconce

A contemporary style wall sconce suitable for interior and exterior use. Available in three finishes and three interchangeable covers to suit a variety of applications,

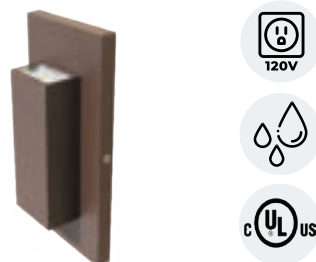

## FEATURES

- Housing: Rugged aluminum construction
- 120V - 277V AC input voltage
- Lumen output 1300LM
- CRI 80+
- LED life: 50,000 hours
- Powder coated finish
- 120° beam angle
- ADA compliant
- Finishes: Brown, Black and Silver
- Three interchangeable covers: Wave, Wing and Scoop
- cULus listed for wet locations

## APPLICATIONS

- Exterior residential & commercial
- Entrance ways
- Hallway lighting
- Patio & deck Lights
- Hotel hallways & restaurants
- Stairways & lobbies

## SPECIFICATIONS

Product Code		TLWMV15XWMZZ
Electrical	Input Voltage	120V - 277V AC
	Power Consumption	15W
Specs	Colour Temperature	3000/4000K
	CRI	80+
	Lumen Output	1300LM
	Efficacy (LM/W)	60
	Dimmable	No
	Beam Angle	120°
LED	Type	LUMILED 3030
	Life Span	>50,000 Hours
Design	Dimensions (Inches)	8 x 4 3/8 x 2 1/8"
	Dimensions (Millimeters)	203 x 111 x 54mm
	Finish	Powder coated finish
	Material	Aluminum
	Operating Temperature	-20 to +40°C
	Approved Location	Outdoor
	Mounting	Wall
Warranty	5 years	
Approvals	cULus listed for wet locations	

3 COVER OPTIONS (Sold separately)

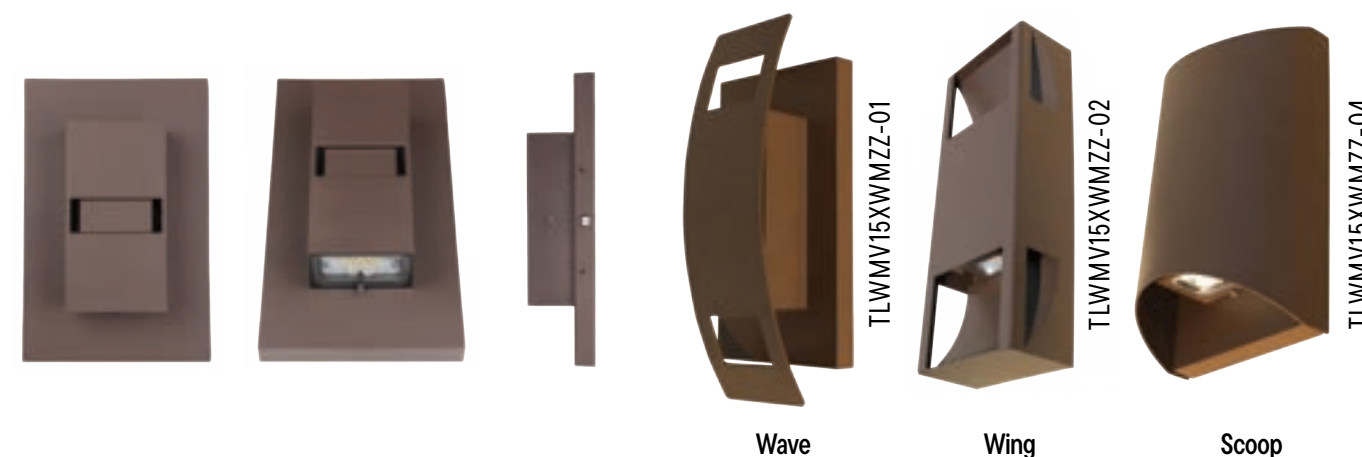

## PRODUCT CODES

## DIAGRAM

### TLWMV15XWMZZ

- LED Outdoor Sconce**
- COLOUR OF LED**  
3 - 3000K  
4 - 4000K
- FINISH**  
BR - Brown  
BK - Black  
SV - Silver

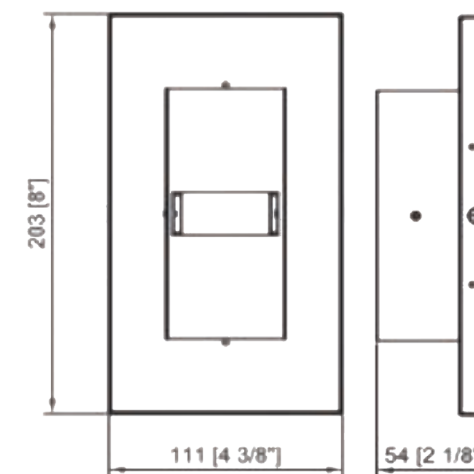

## DIAGRAMS (COVERS)

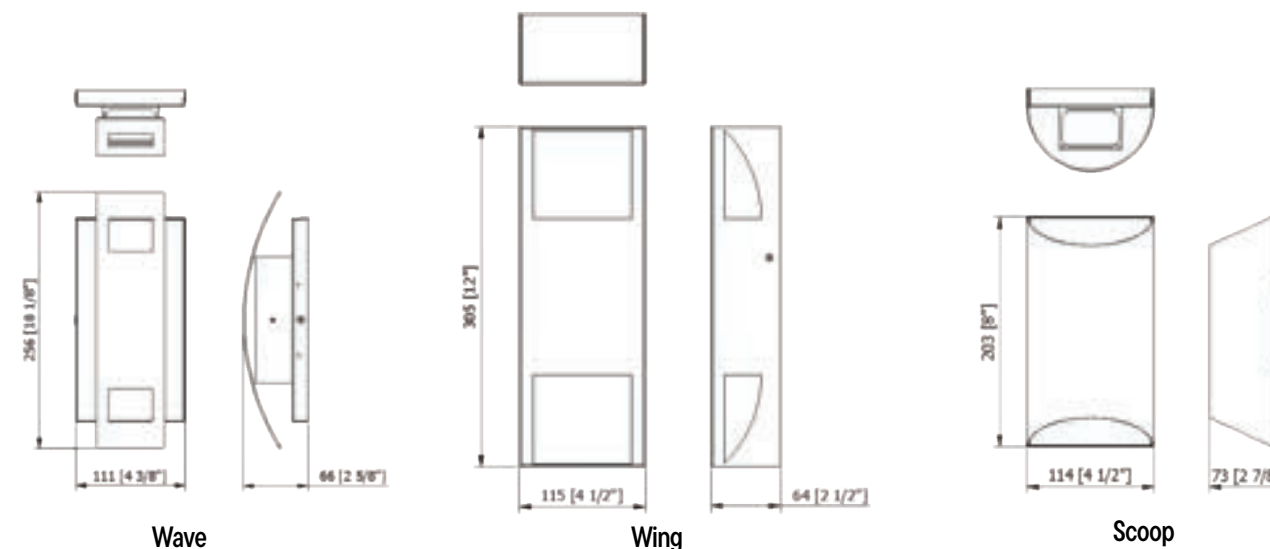

# Brick Star (Gen II)

LED Brick Star enhances stairs, aisles, and paths with attractive, cost-effective lighting, designed to fit standard brick sizes for easy integration and optimal performances,



## FEATURES

- Long-lasting 40,000-hour LED
- Ultra-low energy use: 5.2 watts
- High color accuracy: CRI 80+
- Lens: Frosted tempered glass
- Standard 120VAC input
- Supports up to 150 units per tap
- Durable die-cast aluminum build
- Available in fluorocarbon can with stainless steel louvre cover
- Standard brick size fit
- Compatible with TRIAC dimmers
- 3 years warranty

## APPLICATIONS

- Brick walls
- Exterior steps
- Interior steps
- Aisles
- Halls
- Paths
- Patio lighting
- Entry lighting
- Ceilings
- Showers

## SPECIFICATIONS

Product Code		LBR-II-X-WH-YY
Electrical	Input Voltage	120V AC
	Power Consumption	5.2W
Specs	Colour Temperature	3000K
	CRI	80+
	Lumen Output	468LM
	Efficacy (LM/W)	N/A
	Dimmable	Yes, with TRIAC dimming systems
	Beam Angle	N/A
LED	Life Span	>40,000 Hours
Design	Dimensions (Inches)	3 x 9"
	Dimensions (Millimeters)	76.2 x 228.6mm
	Can Finish	Powder Coated White or Fluorocarbon Lacquer (Stainless Steel)
	Cover Finish	White, Black, Bronze, Aluminum or Stainless Steel finish only available in Louvre cover
	Lens	Frosted tempered glass
	Max Single Run Length	Can be daisy chained up to 150 fixtures per 15A circuit
	Operating Temperature	N/A
	Approved Location	Wet and IC locations, concrete pour, shower
Mounting	Wall, ceiling	
Warranty	3 years	
Approvals	cETLus listed for wall, ceiling, wet and IC locations	

**NOTE:** When installing LED Brick Star in harsh environments (such as limestone, salted areas, coastal environments, etc.) please use the stainless steel version to avoid the risk of corrosion to the body of the fixture.



## PRODUCT CODES

LBR - II - X - WH - YY

LED Brick Star	COVER	COLOUR OF LED	COVER FINISH
	P - Prism	3000K	WH - White
	S - Scoop		BK - Black
	L - Louvre		BZ - Bronze
			AL - Aluminum
			SS - Stainless Steel

## REPLACEMENT KIT

LBR-II-KIT

## CONCRETE CAP

BL-CC

- NOTE: Stainless Steel finish available in Louvre cover only.
- Concrete cap for concrete pour installations.
- NOTE: For outdoor installations, a 1/2" liquid tight strain relief is recommended.

## DIAGRAM

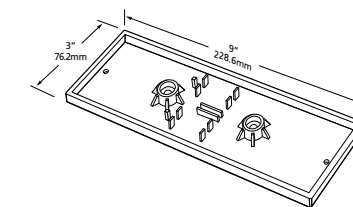
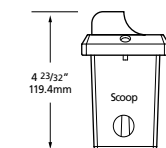
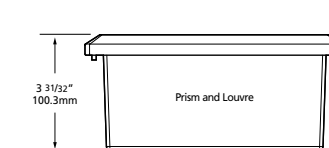
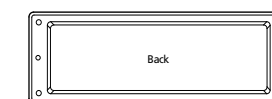
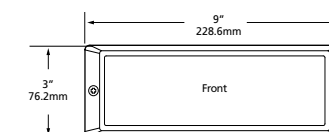
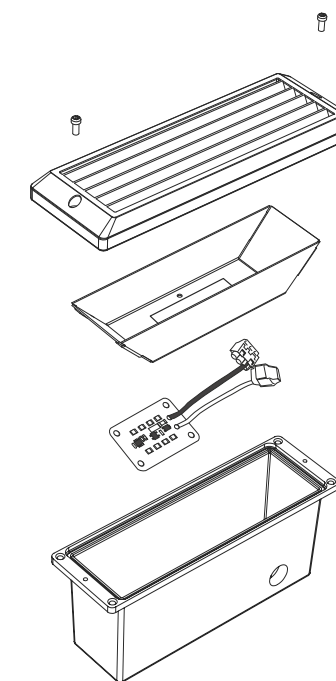

## Concrete Cap (for concrete pour installations)

- Product Code: **BL-CC**
- **IMPORTANT:** It is recommended that you use Magic Lite / NSL's Concrete Cap for concrete pour installations. These caps assist in providing a proper reveal for flush mount of fixture cover after concrete is dry..

# Step Star (Gen II)

LED Step Star offers durable, energy-efficient lighting for stairs and pathways, suitable for both indoor and outdoor use, with a robust cast aluminum build ideal for concrete installations.

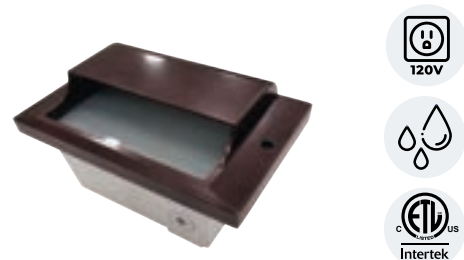

## FEATURES

- 40,000-hour LED lifespan
- Ultra-low energy use: 5.2 watts
- Color accuracy with CRI 80+
- Lens: Frosted tempered glass
- Supports 120VAC power input
- Up to 150 units per 120VAC circuit
- Durable die-cast aluminum enclosure
- Versatile indoor/outdoor certification (cETLus)
- Compatible with TRIAC dimmers
- 3 years warranty

## APPLICATIONS

- Interior stairs
- Exterior stairs
- Aisles
- Hallways
- Paths
- Public areas
- Emergency lighting
- Theaters
- Patios
- Decks

## SPECIFICATIONS

Product Code		LST-II-X-WH-YY
Electrical	Input Voltage	120V AC
	Power Consumption	5.2W
Specs	Colour Temperature	3000K
	CRI	80+
	Lumen Output	468LM
	Efficacy (LM/W)	N/A
	Dimmable	Yes, with TRIAC dimmable systems
	Beam Angle	N/A
LED	Life Span	>40,000 Hours
Design	Dimensions (Inches)	3 x 9"
	Dimensions (Millimeters)	76.2 x 228.6mm
	Can Finish	Powder Coated White
	Cover Finish	White, Black, Bronze, and Aluminum
	Lens	Can be daisy chained up to 150 fixtures per 15A circuit
	Operating Temperature	N/A
	Approved Location	Wet and IC locations
Mounting	Wall, ceiling	
Warranty	3 years	
Approvals	cETLus listed for wall, ceiling, wet and IC locations	

Wiring Options: 20V AC hardwire – can be daisy chained up to 150 fixtures per 15A circuit.

## PRODUCT CODES

LST - II - X - WH - YY

LED	COVER	COLOUR OF LED	COVER FINISH
Step Star	P - Prism	3000K	WH - White
Gen II	S - Scoop		BK - Black
	L - Louvre		BZ - Bronze
			AL - Aluminum

## REPLACEMENT KIT

LST-II-KIT

- Concrete cap for concrete pour installations.
- NOTE: For outdoor installations, a 1/2" liquid tight strain relief is recommended.

## CONCRETE CAP

SL-CC

## DIAGRAM

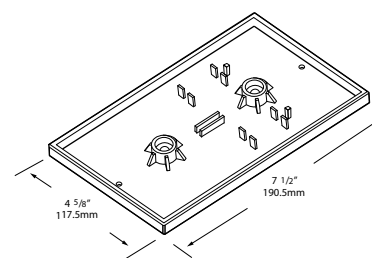
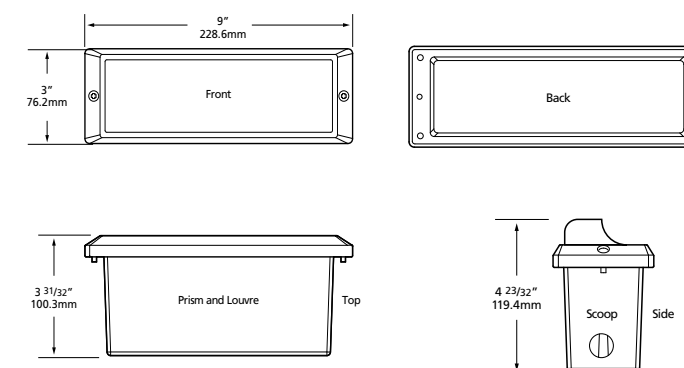
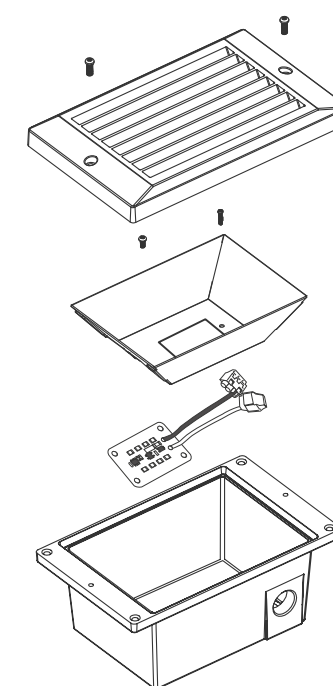

## Concrete Cap (for concrete pour installations)

- Product Code: **SL-CC**
- IMPORTANT: It is recommended that you use Magic Lite / NSL's Concrete Cap for concrete pour installations. These caps assist in providing a proper reveal for flush mount of fixture cover after concrete is dry.

# Switch Star

LED Switch Star is ideal for both indoor and outdoor settings, offering an excellent solution for security or exit lighting. This fixture connects directly to 120V without the need for remote drivers, simplifying installation.



## FEATURES

- 1.4W power consumption
- Mounts on 2" x 4" boxes
- Outdoor/indoor ready
- Louvre/scoop/prism covers
- Horizontal/vertical mounting
- 3 color choices

- Dimmable functionality
- 40,000-hour LED lifespan
- cETLus safety certified
- 3 years warranty

## APPLICATIONS

- Hallways, stairways
- Night light
- Decks, patios
- Garages, elevators
- Commercial/residential exteriors

## SPECIFICATIONS

SPECIFICATIONS		LED-SW-X-Y
<b>Product Code</b>	LED-SW-X-Y	
<b>Electrical</b>	Input Voltage	120V AC, .012A
	Power Consumption	1.4W
<b>Specs</b>	Colour Temperature	2700K or Amber
	CRI	80+
	Lumen Output	468LM
	Efficacy (LM/W)	57
	Dimmable	No
	Beam Angle	120°
<b>LED</b>	Type	AC LED
	Life Span	40,000 Hours to 70% Lumen output
<b>Design</b>	Dimensions (Inches)	5.07 x 3.03"
	Dimensions (Millimeters)	129 x 77mm
	Finish	White, Light Almond, Brown Wood Grain
	Material	Polycarbonate (5VA flame rated, F1 UV rated) & Glass
	Operating Temperature	-30°C to 60°C
	Approved Location	Indoor/Outdoor
<b>Mounting</b>	N/A	
<b>Warranty</b>	3 years	
<b>Approvals</b>	cETLus listed	

## PRODUCT CODES

### LED-SW-X-Y

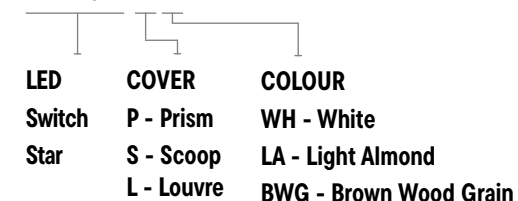

- Note: Add (-AM) on the part number for Amber LED fixture
- Scoop and Louvre covers are supplied in both horizontal and vertical.



### LED-SW-X-Y-COV

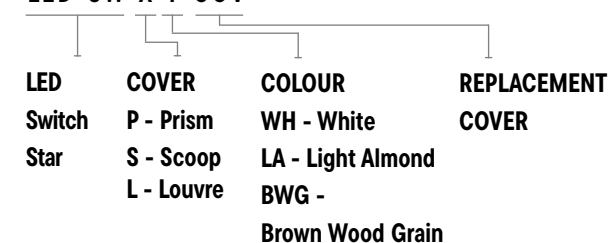

## COVER DIMENSIONS

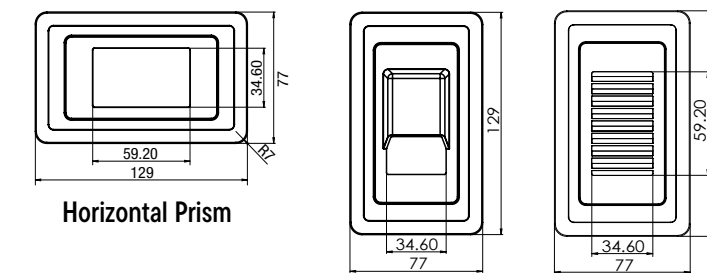

## COVER STYLES

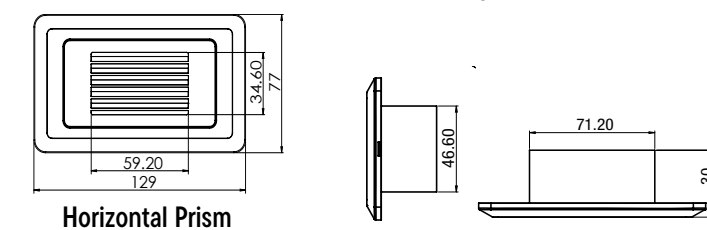
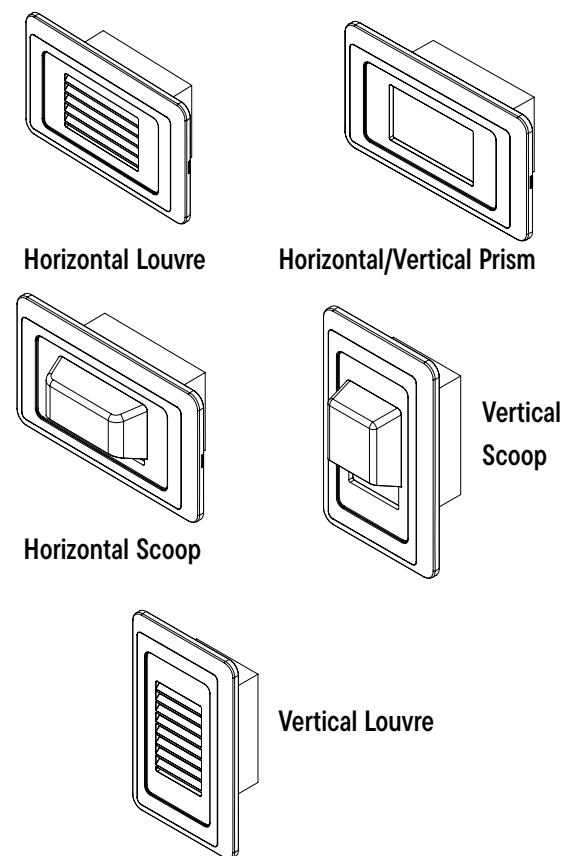

Prism and Louvre (Side & Top)

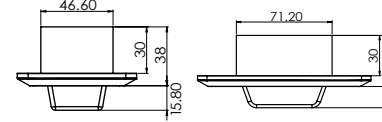

Scoop (Side & Top)



# Disc Light

Versatile and robust, the LED Disc Light offers powerful illumination for both public and residential areas, whether indoors or outdoors. Durable and certified for wet conditions, it's great for enhancing decks, driveways, and patios with simple concrete pour setup.



## FEATURES

- Fully dimmable with dimmable power supply (sold separately)
- 50,000-Hour LED life
- Low power consumption: 3 watts per fixture
- Safe 12 volt, Class 2 power supply (not included)
- Up to 30 fixtures per power supply
- Lens: Frosted or clear tempered glass
- cETLus listed
- Fits 1.5" diameter hole
- No UV, no infrared, no radiated heat
- 3 years warranty

## APPLICATIONS

- Steps
- Aisles
- Paths
- Driveways
- Direction lighting
- Information lighting
- Decorative lighting
- Merchandising
- Landscape accents

## SPECIFICATIONS

Product Code	LEDD-Y-XX (ROUND)	LEDD-Y-XX-SQ (SQUARE)
<b>Electrical</b>	Input Voltage	12V AC
	Power Consumption	3W
<b>Specs</b>	Colour Temperature	Cool White 98 lumens @ 5400K; Warm White 95 lumens @ 2900K
	CRI	80+
	Lumen Output	900LM Max.
	Efficacy (LM/W)	83
	Dimmable	Yes
	Beam Angle	N/A
<b>LED</b>	Type	5050
	Life Span	50,000 Hours
<b>Design</b>	Dimensions (Inches)	2.36 x 3.9"
	Dimensions (Millimeters)	60 x 99mm
	Cover Finish	Stainless steel
	Barrel Finish	Stainless steel
	Max Single Run Length	18 fixtures
	Approved Location	Outdoor
<b>Mounting</b>	Recessed	
<b>Warranty</b>	3 years	
<b>Approvals</b>	cETLus listed and labeled for wet, IC, ceiling, wall and direct burial applications	

**NOTE:** When installing Mini Disc Lights in harsh environments (such as limestone, salted areas, coastal environments, etc.) please use the stainless steel version to avoid the risk of corrosion to the body of the fixture.

## DIAGRAM

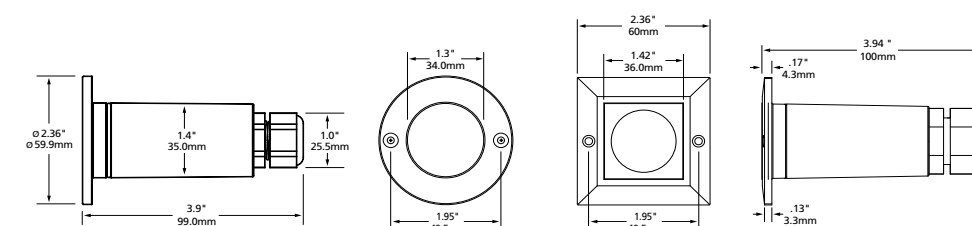

## PRODUCT CODES

### ROUND

#### LEDD-Y-XX

LED Disc Light	TEMPERED GLASS	COLOUR OF LED
F - Frosted	WH - 5500K	WW - 2700K
C - Clear	AM - Amber	

### SQUARE

#### LEDD-Y-XX-SQ

LED Disc Light	TEMPERED GLASS	COLOUR OF LED
F - Frosted	WH - 5500K	WW - 2700K
C - Clear	AM - Amber	

## REPLACEMENT LED MODULES

- LEDD-MOD-WH**  
LED Disc Light module, 12V, white LED 5500K
- LEDD-MOD-WW**  
LED Disc Light module, 12V, warm white LED 2700K

## INSTALLATION WIRES

- LW-18G-BUR**  
For outdoor burial connections
- LW-18G-CL2**  
For indoor through wall connections

**NOTE:** One of the above wires **MUST** be used in order to maintain product warranty.

## ACCESSORIES



### LEDD-CF

LED Disc Light concrete form for concrete pour applications. Fits over most 3/4" conduit junction boxes.

### LEDD-CF-SQ

LED Disc Light Square concrete form for concrete pour applications. Fits over most 3/4" conduit junction boxes.

## DIMMABLE DRIVERS

### TR12L20DC

20 Watts  
Max. recommended load 18 W or 6 LED Disc Lights  
Min. recommended load 8 W or 3 LED Disc Lights  
6.77" x 2.67" x 1.26" (171 x 68 x 32mm)

### TR12L60DC

60 Watts  
Max. recommended load 54 W or 18 LED Disc Lights  
Min. recommended load 8 W or 3 LED Disc Lights  
6.77" x 2.67" x 1.26" (171 x 68 x 32mm)

## NON DIMMABLE DRIVERS

### LEDDR-12-60W (Indoor/Outdoor)

60W hardwire  
Input: 100 - 240V AC; Output: 12V DC  
Max. 18 LED Disc Lights  
9 11/16" x 2 9/16" x 2 1/16" (246 x 65 x 52mm)

## 100% LED Light Output Chart

With every foot of lead wire and every light fixture, there is voltage loss. With too much voltage loss all light fixtures will not develop 100% of their potential output. Below is a chart of acceptable voltage loss which will maintain 100% of the potential light output of the LED Disc Light. Simply plot the number of LED Disc Light you wish to place on one lead on the horizontal axis, with the total distance from the LED Driver to the last LED Disc Light on the vertical axis. If the resulting plot is at or below the line shown, you will have acceptable voltage loss and your LED Disc Light will output 100% of their potential.

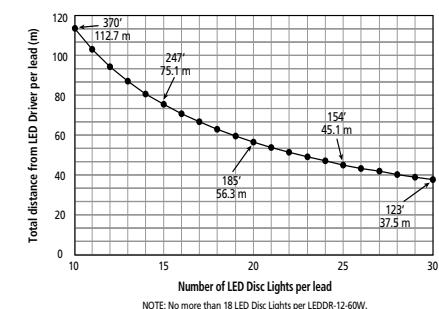

## WARNING: LACK OF DRAINAGE WILL VOID THE WARRANTY

To maintain the warranty, a proper drainage system **MUST** be installed (drainage material or drainage pipe), when the product is installed in soil or concrete.

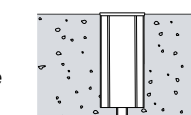

Concrete Installation

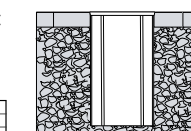

Paving Stones

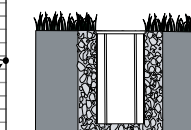

Soil Installation

## Test drainage prior to installation.

A quantity of water equal to the volume of the mounting hole should drain in 15 minutes or less.

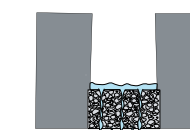

SOFT GROUND

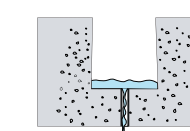

HARD GROUND

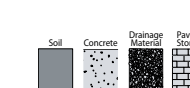

# Mini Disc Marker Light

Robust and energy-efficient, the LED Mini Disc Light, with its durable construction and low 0.24W consumption, suits a multitude of indoor/outdoor applications. It offers long-lasting illumination in both round and square designs, ensuring compatibility with any décor at an affordable cost.



## FEATURES

- Dimmable on the primary power supply side with drivers
- 50,000 hour durability
- Ultra-low consumption: 0.24 watts per fixture
- 12V class 2 safety
- Up to 100 fixtures per supply
- cETLus certified
- Fits 1" diameter, 3.5" depth
- Lens: Frosted Tempered Glass
- 2 years limited warranty, 3 years on stainless steel

## APPLICATIONS

- Steps
- Aisles
- Paths
- Driveways
- Direction lighting
- Information lighting
- Decorative lighting
- Merchandising
- Landscape accents

## SPECIFICATIONS

Product Code	LEDMD-XX-YY (ROUND)	LEDMD-XX-YY-SQ (SQUARE)
<b>Electrical</b>	Input Voltage	12V DC
	Power Consumption	0.24W
<b>Specs</b>	Colour Temperature	Cool White 5400K, Warm White 2900K, Blue, Green, Amber, Red
	CRI	N/A
	Lumen Output	17
	Efficacy (LM/W)	N/A
	Dimmable	Yes
	Beam Angle	N/A
<b>LED</b>	Life Span	50,000 Hours
<b>Design</b>	Dimensions (Inches)	3 1/4 x 2"
	Dimensions (Millimeters)	82.6 x 50.8mm
	Cover Finish	Aluminum, White, Bronze, Black, Stainless Steel
	Barrel Finish	Aluminum, White, Bronze, Black, Stainless Steel
	Material	Both cover and barrel are die cast aluminum
	Lens	Frosted tempered glass
	Approved Location	Outdoor
	Mounting	N/A
<b>Warranty</b>	3 years	
<b>Approvals</b>	cETLus listed and labeled for wet, IC, ceiling, wall and direct burial applications	

- **NOTE:** When installing Mini Disc Lights in harsh environments (such as limestone, salted areas, coastal environments, etc.) please use the stainless steel version to avoid the risk of corrosion to the body of the fixture.
- Each LED Driver can power up to 200 LED MiniDisc Lights by parallel wiring ("daisy chain") between fixtures.
- **NOTE:** Use LW-18G-CL2 for all in-wall applications, LW-18G-BUR for all burial applications.

## DIAGRAM

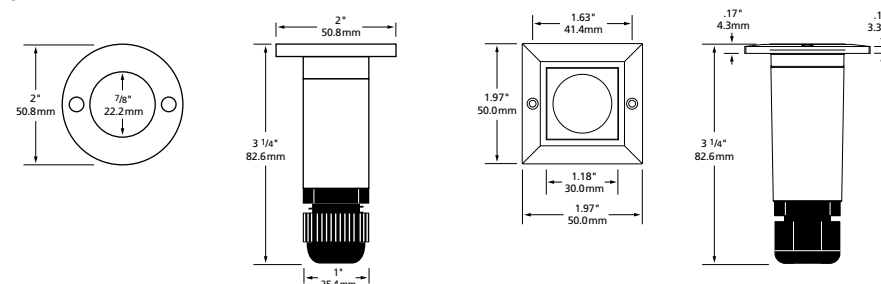

## PRODUCT CODES

### ROUND

#### LEDMD-XX-YY

LED	COLOUR OF LED	FINISH
MiniDisc	CW - 5400K	AL - Aluminum
Light	WW - 2900K	WH - White
	AM - Amber	BZ - Bronze
	BL - Blue	BK - Black
	GR - Green	SS - Stainless Steel
	RD - Red	

### SQUARE

#### LEDMD-XX-YY-SQ

LED	COLOUR OF LED	FINISH
MiniDisc	CW - 5400K	AL - Aluminum
Light	WW - 2900K	WH - White
	AM - Amber	BZ - Bronze
	BL - Blue	BK - Black
	GR - Green	SS - Stainless Steel
	RD - Red	

## REPLACEMENT LED MODULES

- **LCL-LEDMOD-WH**  
LED Mini Disc Light module, 12V, white LED 5400K
- **LCL-LEDMOD-WW**  
LED Mini Disc Light module, 12V, warm white LED 2900K

## INSTALLATION WIRES

- **LW-18G-BUR**  
For outdoor burial connections
- **LW-18G-CL2**  
For indoor through wall connections

**NOTE:** One of the above wires **MUST** be used in order to maintain product warranty.

## 100% LED Light Output Chart

With every foot of lead wire and every light fixture, there is voltage loss. With too much voltage loss all light fixtures will not develop 100% of their potential output. Below is a chart of acceptable voltage loss which will maintain 100% of the potential light output of the LED Disc Light. Simply plot the number of LED Disc Light you wish to place on one lead on the horizontal axis, with the total distance from the LED Driver to the last LED Disc Light on the vertical axis. If the resulting plot is at or below the line shown, you will have acceptable voltage loss and your LED Disc Light will output 100% of their potential.

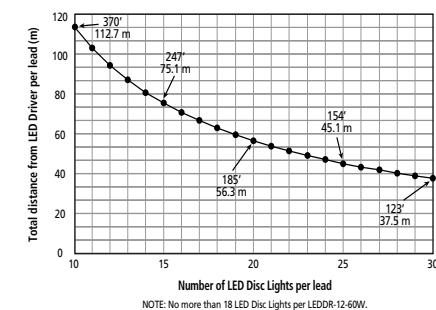

## WARNING: LACK OF DRAINAGE WILL VOID THE WARRANTY

To maintain the warranty, a proper drainage system **MUST** be installed (drainage material or drainage pipe), when the product is installed in soil or concrete.

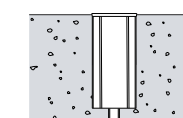

Concrete Installation

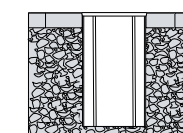

Paving Stones

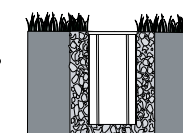

Soil Installation

## Test drainage prior to installation.

A quantity of water equal to the volume of the mounting hole should drain in 15 minutes or less.



SOFT GROUND

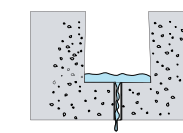

HARD GROUND

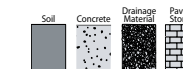

## ACCESSORIES



### LEMD-CF

LED Mini Disc Light concrete form for concrete pour applications. Fits over most 1/2" (12.7mm) conduit junction boxes.

### LEMD-CF-SQ

LED MiniDisc Light Square concrete form for concrete pour applications. Fits over most 1/2" (12.7mm) conduit junction boxes.

## DIMMABLE DRIVERS

### TR12L20DC

20 Watts  
Max. recommended load 18 W or 75 Mini Disc Lights  
Min. recommended load 8 W or 34 Mini Disc Lights  
6.77" x 2.67" x 1.26" (171 x 68 x 2mm)

### TR12L60DC

60 Watts  
Max. recommended load 54 W or 200 Mini Disc Lights  
Min. recommended load 8 W or 34 Mini Disc Lights  
6.77" x 2.67" x 1.26" (171 x 68 x 32mm)

## NON DIMMABLE DRIVERS

### LEDDR-12-60W (Indoor/Outdoor)

60W hardware  
Input: 100 - 240V AC  
Output: 12V DC  
Max. 200 Mini Disc Lights  
9 11/16" x 2 9/16" x 2 1/16" (246 x 65 x 52mm)

# Mini Disc Light (Scoop)

The LED Mini Disc Scoop directs light precisely, ideal for stair and theater aisle lighting. It's durable and efficient, offering a 50,000-hour lifespan and low 0.24W consumption, fitting easily into 1" holes. Certified for diverse environments, it ensures safety and versatility with a solid warranty.



## FEATURES

- Dimmable on the primary power supply side with drivers
- 50,000 hour durability
- Ultra-low consumption: 0.24 watts per fixture
- 12V class 2 safety
- Up to 100 fixtures per supply
- cETLus certified
- Fits 1" diameter, 3.5" depth
- Lens: Frosted Tempered Glass
- 2 years limited warranty, 3 years on stainless steel

## APPLICATIONS

- Steps
- Aisles
- Paths
- Driveways
- Direction lighting
- Information lighting
- Decorative lighting
- Merchandising
- Landscape accents

SPECIFICATIONS		
<b>Product Code</b>	LEDMD-S-XX-YY	
<b>Electrical</b>	Input Voltage	12V DC
	Power Consumption	0.24W
<b>Specs</b>	Colour Temperature	Cool White 5400K, Warm White 2900K, Blue, Green, Amber, Red
	CRI	N/A
	Lumen Output	17
	Efficacy (LM/W)	N/A
	Dimmable	Yes
<b>LED</b>	Life Span	50,000 Hours
	Beam Angle	N/A
<b>Design</b>	Dimensions (Inches)	2 x 3 1/4"
	Dimensions (Millimeters)	50.8 x 82.6mm
	Cover Finish	Aluminum, White, Bronze, Black
	Barrel Finish	Aluminum, White, Bronze, Black
	Lens	Frosted tempered glass
	Max Single Run Length	200 fixtures
	Approved Location	Outdoor
<b>Warranty</b>	2 years	
<b>Approvals</b>	cETLus listed and labeled for wet, IC, ceiling, wall and direct burial applications	

- **NOTE:** When installing Mini Disc Scoop in harsh environments (such as limestone, salted areas, coastal environments, etc.) please use the stainless steel version to avoid the risk of corrosion to the body of the fixture.
- Each LED Driver can power up to 200 Mini Disc Lights by parallel wiring ("daisy chain") between fixtures.
- **NOTE:** Use LW-18G-CL2 for all in-wall applications, LW-18G-BUR for all burial applications.

## DIAGRAM

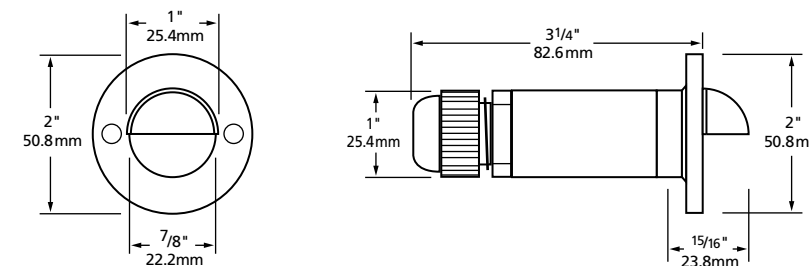

## PRODUCT CODES

### LEDMD-S-XX-YY

LED	COLOUR OF LED	FINISH
Mini Disc Light (Scoop)	CW - 5400K WW - 2900K AM - Amber BL - Blue GR - Green RD - Red	AL - Aluminum WH - White BZ - Bronze BK - Black

## REPLACEMENT LED MODULES

- **LCL-LEDMOD-WH**  
LED Mini Disc Light module, 12V, white LED 5400K
- **LCL-LEDMOD-WW**  
LED Mini Disc Light module, 12V, warm white LED 2900K

## INSTALLATION WIRES

- **LW-18G-BUR**  
For outdoor burial connections
- **LW-18G-CL2**  
For indoor through wall connections

**NOTE:** One of the above wires **MUST** be used in order to maintain product warranty.

## ACCESSORIES



### LEDD-CF

LED Disc Light concrete form for concrete pour applications. Fits over most 3/4" conduit junction boxes.

## DIMMABLE DRIVERS

### TRE12L20DC

20 Watts  
Max. recommended load 18 W or 75 Mini Disc Lights

Min. recommended load 8 W or 34 Mini Disc Lights

6.77" x 2.67" x 1.26" (171 x 68 x 2mm)

### TRE12L60DC

60 Watts  
Max. recommended load 54 W or 200 Mini Disc Lights

Min. recommended load 8 W or 34 Mini Disc Lights

6.77" x 2.67" x 1.26" (171 x 68 x 32mm)

**NOTE:** For outdoor installations, please add E-KO-SR strain relief.

## NON DIMMABLE DRIVERS

### LEDDR-12-60W (Indoor/Outdoor)

60W hardwire  
Input: 100 - 240V AC  
Output: 12V DC  
Max. 200 Mini Disc Lights  
9 11/16" x 2 9/16" x 2 1/16" (246 x 65 x 52mm)

## 100% LED Light Output Chart

With every foot of lead wire and every light fixture, there is voltage loss. With too much voltage loss all light fixtures will not develop 100% of their potential output. Below is a chart of acceptable voltage loss which will maintain 100% of the potential light output of the LED Disc Light. Simply plot the number of LED Disc Light you wish to place on one lead on the horizontal axis, with the total distance from the LED Driver to the last LED Disc Light on the vertical axis. If the resulting plot is at or below the line shown, you will have acceptable voltage loss and your LED Disc Light will output 100% of their potential.

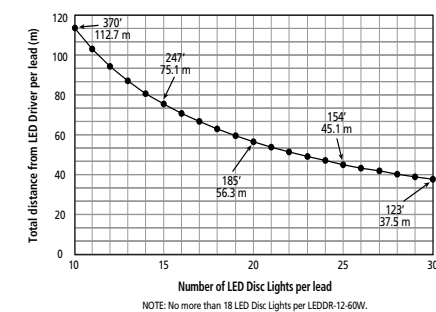

## WARNING: LACK OF DRAINAGE WILL VOID THE WARRANTY

To maintain the warranty, a proper drainage system **MUST** be installed (drainage material or drainage pipe), when the product is installed in soil or concrete.

**Test drainage prior to installation.**  
A quantity of water equal to the volume of the mounting hole should drain in 15 minutes or less.

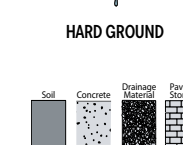
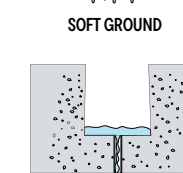
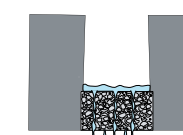
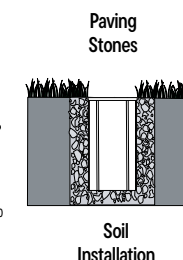
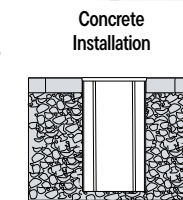
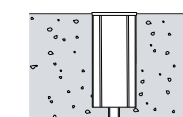

# Disc Light Dome

## Stainless Steel Construction

Durable LED marker light with dimming capability, perfect for indoor and outdoor use. Stainless steel construction ensures longevity in any setting.

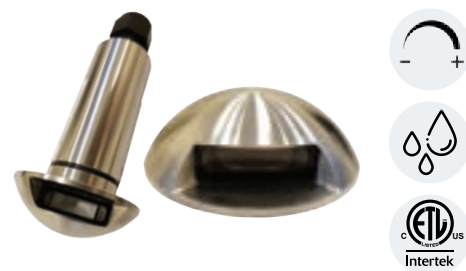

### FEATURES

- Dimmable with dimmable power supplies
- Long life – 50,000 hours
- Low power consumption 3 watts per fixture
- Safe 12 volt, Class 2 power supply (not included)
- Up to 30 fixtures per power supply
- cETLus listed
- Fits in any 1.5" diameter hole, 4" long
- Lens: Clear tempered glass
- Available concrete form for concrete pour applications
- 3 years limited warranty

### APPLICATIONS

- Steps
- Aisles
- Paths
- Driveways
- Direction lighting
- Decorative lighting

### SPECIFICATIONS

SPECIFICATIONS		LEDD-C-XX-D
<b>Product Code</b>	LEDD-C-XX-D	
<b>Electrical</b>	Input Voltage	12V DC
	Power Consumption	3W
<b>Specs</b>	Colour Temperature	Cool White 98 lumens @ 5500K; Warm White 95 lumens @ 2700K
	CRI	80+
	Lumen Output	5500K: 98; 2700K: 95
	Efficacy (LM/W)	N/A
	Dimmable	Yes
	Beam Angle	N/A
<b>LED</b>	Type	5050
	Life Span	50,000 Hours
<b>Design</b>	Dimensions (Inches)	3.9 x 1.95"
	Dimensions (Millimeters)	99 x 49.6mm
	Cover Finish	Stainless Steel (SUS316)
	Barrel Finish	Stainless Steel (SUS316)
	Max Single Run Length	18 fixtures
	Approved Location	Outdoor
	Mounting	Burial, wall
<b>Warranty</b>	3 years	
<b>Approvals</b>	cETLus listed and labeled for wet, IC, ceiling, wall and direct burial applications	

- **Wiring Options:** Fixtures can be parallel wired or "Daisy chained" together with up to 18 fixtures on our largest dimmable driver.
- **NOTE:** Use LW-18G-CL2 for all in-wall applications. Use LW-18G-BUR for all burial applications.

### DIAGRAM

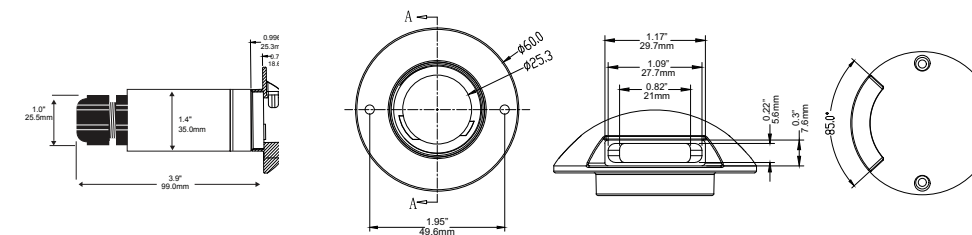

### PRODUCT CODES

#### LEDD-C-XX-D

- LED Disc Light (Dome)**
- COLOUR OF LED**
- WH - 5500K**
- WW - 2700K**

### REPLACEMENT LED MODULES

- **LEDD-MOD-WH**  
LED Disc Light module, 12V, white LED 5500K
- **LEDD-MOD-WW**  
LED Disc Light module, 12V, warm white LED 2700K

### INSTALLATION WIRES

- **LW-18G-BUR**  
For outdoor burial connections
- **LW-18G-CL2**  
For indoor through wall connections

**NOTE:** One of the above wires **MUST** be used in order to maintain product warranty.

### ACCESSORIES



#### LEDD-CF

Recommended for easy installation in concrete pour applications.

### DIMMABLE DRIVERS

#### TRE12L20DC

20 Watts  
Max. recommended load 18 W or 6 LED Disc Lights  
Min. recommended load 8 W or 3 LED Disc Lights  
6.77" x 2.67" x 1.26" (171 x 68 x 32mm)

#### TRE12L60DC

60 Watts  
Max. recommended load 54 W or 18 LED Disc Lights  
Min. recommended load 8 W or 3 LED Disc Lights  
6.77" x 2.67" x 1.26" (171 x 68 x 32mm)

**NOTE:** For outdoor installations, please add E-KO-SR strain relief.

### NON DIMMABLE DRIVERS

#### LEDDR-12-60W (Indoor/Outdoor)

60W hardwire  
Input: 100 - 240V AC; Output: 12V DC  
Max. 18 LED Disc Lights  
9 11/16" x 2 9/16" x 2 1/16" (246 x 65 x 52mm)

### 100% LED Light Output Chart

With every foot of lead wire and every light fixture, there is voltage loss. With too much voltage loss all light fixtures will not develop 100% of their potential output. Below is a chart of acceptable voltage loss which will maintain 100% of the potential light output of the LED Disc Light. Simply plot the number of LED Disc Light you wish to place on one lead on the horizontal axis, with the total distance from the LED Driver to the last LED Disc Light on the vertical axis. If the resulting plot is at or below the line shown, you will have acceptable voltage loss and your LED Disc Light will output 100% of their potential.

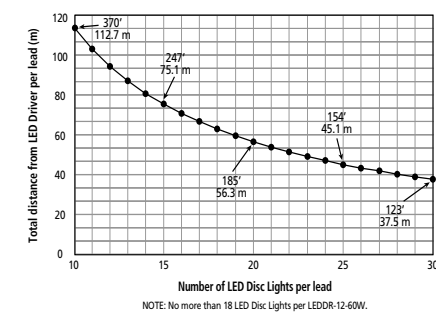

NOTE: No more than 18 LED Disc Lights per LEDDR-12-60W.

### WARNING: LACK OF DRAINAGE WILL VOID THE WARRANTY

To maintain the warranty, a proper drainage system **MUST** be installed (drainage material or drainage pipe), when the product is installed in soil or concrete.

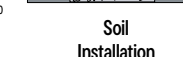
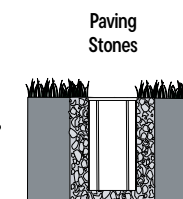
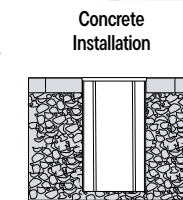
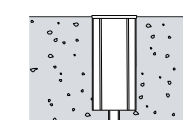

### Test drainage prior to installation.

A quantity of water equal to the volume of the mounting hole should drain in 15 minutes or less.

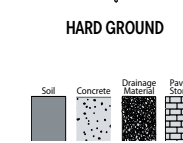
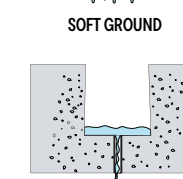
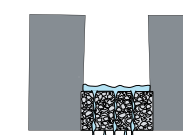

# Well Light

Illuminate columns, fences, and trees discreetly with this well light. Designed for flush installation, it features a robust die-cast aluminum housing and a powerful integrated 6-watt LED. Waterproof and backed by a 15-year warranty.



## FEATURES

- Low-profile design for discreet lighting
- Robust die-cast aluminum construction
- Silicon filled wirenuts
- IP67 rated
- Wet location listed
- Powerful 6-watt integrated LED
- Weatherproof for outdoor durability
- Bright 580-lumen output
- Stylish black finish for modern appeal
- Effortless installation with included sleeve
- Backed by 15 years warranty

## APPLICATIONS

- Column and pillar illumination
- Pathway and boundary lighting
- Tree canopy highlighting
- Garden and seating area visibility
- Water feature enhancement
- Step and stair safety lighting



## SPECIFICATIONS

Product Code	IG-01-12V-36D-BLK		IG-01-12V-60D-BLK	
Electrical	Input Voltage	12/24V AC/DC		
	Power Consumption	6W		
Specs	Colour Temperature	3000K		
	CRI	90+		
	Lumen Output	580LM		
	Efficacy (LM/W)	97		
	Dimmable	N/A		
	Beam Angle	36°		60°
LED	Type	SMD2835		
	Life Span	50,000 Hours		
Design	Dimensions (Inches)	3.03 x 4.02"		
	Dimensions (Millimeters)	76.9 x 102 mm		
	Finish	Black		
	Material	Die-cast Aluminum		
	Cable	Copper		
	Operating Temperature	-20 to 40°C		
	Approved Location	Outdoor		
	Mounting	In-ground		
Warranty	15 years			
Approvals	cETLus			

## DIAGRAM

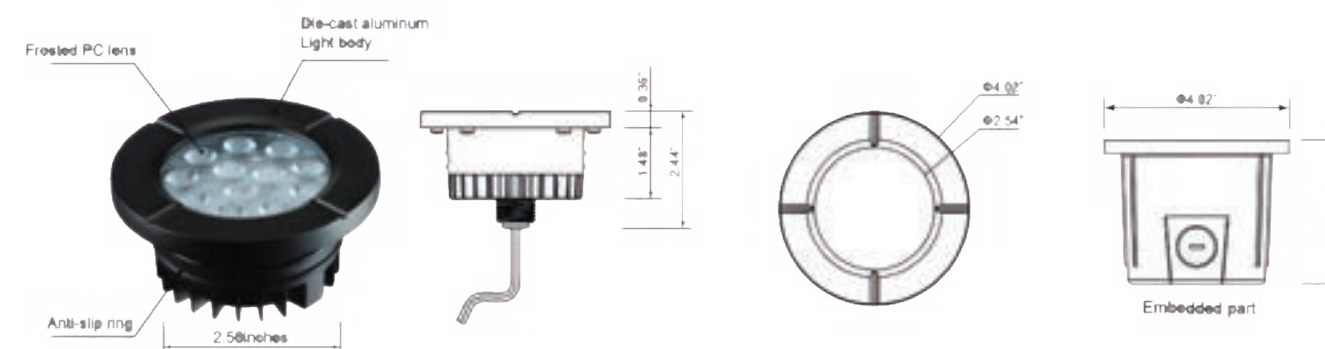

# 12V AC, 100W Transformer

A small transformer for smaller installations. Comes with built in photocell and mechanical timer.



## FEATURES

- Composite body
- Built-in mechanical timer
- Built-in photocell
- 12V/100W output, 120V input
- Transparent sliding lid design
- Overload protection
- IP65 weatherproof
- 72" SJT(W) cable, heavy gauge, grounded and water resistant power cord with molded plug
- 50,000 hour life
- 2 comm terminals
- 12V, 15V terminals
- 15 years warranty
- 7.5" by 4.4" by 4.5"

## SPECIFICATIONS

Product Code		ACC-TR-100W
Electrical	Input Voltage	120V
	Output Voltage	12V AC
	Power	100W
	Max Output Current	8.5A
Specs	Colour Temperature	Cool White 98 lumens @ 5500K; Warm White 95 lumens @ 2700K
	CRI	N/A
	Lumen Output	N/A
	Efficacy (LM/W)	N/A
	Dimmable	N/A
	Beam Angle	N/A
	Life Span	50,000 Hours
Design	Dimensions (Inches)	7.5 x 4.33"
	Dimensions (Millimeters)	190 x 110mm
	Finish	Black
	Material	Composite
	Operating Temperature	-20 to 40°C
	Mounting	On Wall
	IP Rating	IP65
Warranty		15 years
Approvals		cETLus



## DIAGRAM

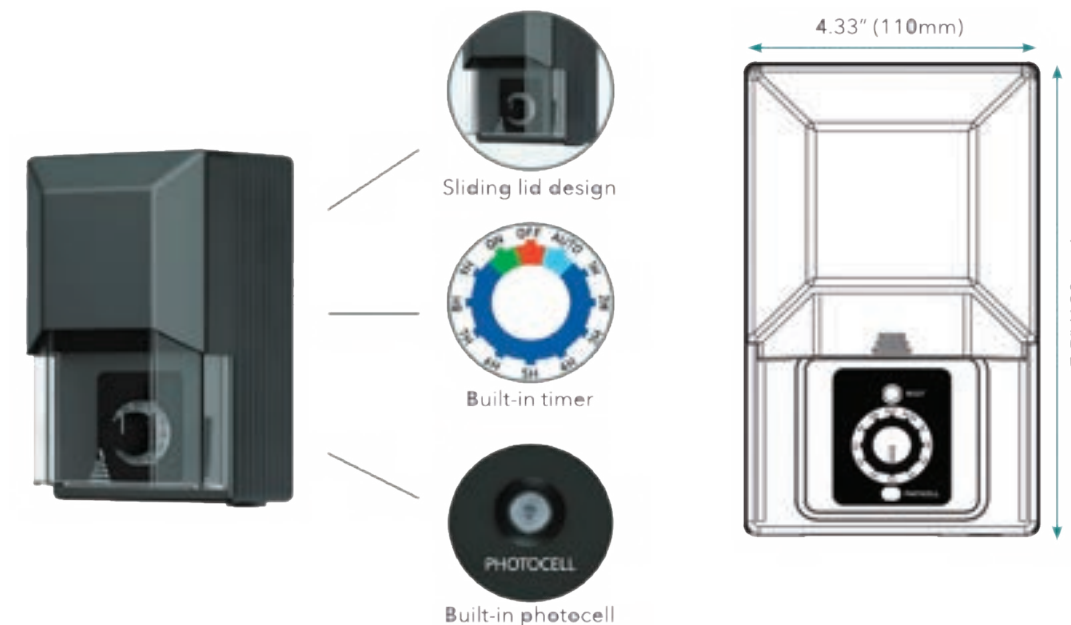

# 12-15V AC, 300W Transformer

A 300W transformer, in a stainless-steel case. Enough power to run most landscape light systems. For bigger properties, run 2 units.



## FEATURES

- Stainless steel case
- 300W output, 110V input
- 1 common terminal, with 12V, 13V, 14V, 15V terminals
- 6.1" by 5.3" by 11.6" dimensions
- Quick mount bracket
- Sealed removable lockable hinged door
- Pre-scored knockout sides and bottom panel
- Tool-less removable bottom panel
- Fully encapsulated Toroid Core
- 304L stainless steel enclosure
- 15 years warranty



SPECIFICATIONS		
<b>Product Code</b>	ACC-TR-300W	
<b>Electrical</b>	Input Voltage	120V
	Output Voltage	12V, 13V, 14V, 15V AC
	Power	300W
	Max Output Current	8.5A
	Primary Protection	25 AMP breaker
<b>Specs</b>	Colour Temperature	Cool White 98 lumens @ 5500K; Warm White 95 lumens @ 2700K
	CRI	N/A
	Lumen Output	N/A
	Efficacy (LM/W)	N/A
	Dimmable	N/A
	Beam Angle	N/A
	Life Span	50,000 Hours
<b>Design</b>	Dimensions (Inches)	11.6 x 6.1"
	Dimensions (Millimeters)	295 x 155mm
	Finish	Black
	Material	Composite
	Operating Temperature	-20 to 40°C
	Mounting	On Wall
	IP Rating	IP65
<b>Warranty</b>	15 years	
<b>Approvals</b>	cETLus	

## DIAGRAM



## ACCESSORIES

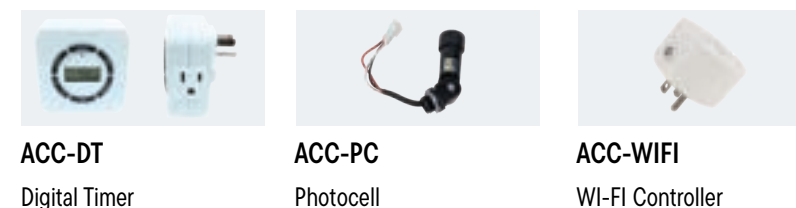

**ACC-DT**  
Digital Timer

**ACC-PC**  
Photocell

**ACC-WIFI**  
WI-FI Controller



# Down Lighting





# 5CCT LED Thin Line Down Light (Round)

Ideal for both commercial and residential settings, this versatile and cost-effective down light offers adjustable 5 color temperatures.

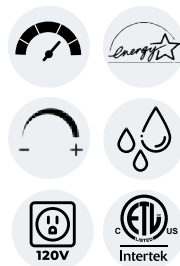

## FEATURES

- TRIAC dimmable
- 120° beam spread
- Adjustable colour temperature
- Two spring loaded clips to attach to any ceiling material
- White finish (interchangeable: brushed nickel, black, bronze trim rings available - sold separately)
- Wet locations listed
- Temperature rating: -20°C to 45°C
- No IC can required, for direct contact with insulation and combustible materials
- Connects directly to 120V power supply
- Optional 347V Step-Down Transformer (non-dimmable)

## APPLICATIONS

- Kitchens & pantries
- Laundry rooms
- Bathrooms
- Lobbies & hallways
- Banquet halls & elevators
- Retail lighting
- Offices & restaurants

## SPECIFICATIONS

Size	3 Inches	4 Inches	6 Inches	8 Inches	10 Inches
<b>Product Code</b>	DL-5CCT-3-WH	DL-5CCT-4-WH	DL-5CCT-6-WH	DL-5CCT-8-WH	DL-5CCT-10-WH
<b>Electrical</b>	Input Voltage: 120V AC Power Consumption: 6W, 9W, 12W, 15W, 20W Color Temperature: 2700/3000/3500/4000/5000K				
<b>Specs</b>	Lumen Output: 420-445, 627-684, 995-1117, 1368-1465, 1817-1944 Efficacy: 70LM/W CRI: 90 Dimmable: Yes (TRIAC) Beam Angle: 120°				
<b>LED</b>	Type: Epistar Life Span: 50,000 Hours				
<b>Design</b>	Dimensions (Inches): 3.1 x 3.8 x .5", 4 x 4.7 x .5", 6.14 x 6.85 x 0.5", 8 x 8.9 x 0.5", 10 x 10.8 x 0.5" Dimensions (Millimeters): 80 x 95.5 x 11.5mm, 101 x 120.1 x 11.5mm, 150 x 174.5 x 11.5mm, 220 x 226 x 11.5mm, 254 x 274 x 11.5mm Installation Hole Size: 3.35" (85mm), 4.33" (110mm), 6.3" (160mm), 8.27" (210mm), 10.16" (258mm) Finish: White Trim Finish: BK: Black, BZ: Bronze, BN: Brushed Nickel Operating Temperature: -20°C to 45°C Approved Location: Wet Mounting: Ceiling				
<b>Warranty</b>	5 years				
<b>Approvals</b>	cETLus and Energy Star				

## PRODUCT CODES

DL-5CCT-YY-WH

5CCT LED Thin-Line Down Lights  
 SIZE: 3: 3", 4: 4", 6: 6", 8: 8", 10: 10"

## ROUND TRIM RINGS (Sold Separately)

- LVLDL - 03 - TR - XX - L3
- LVLDL - 04 - TR - XX - L3
- LVLDL - 06 - TR - XX - L3
- LVLDL - 08 - TR - XX - L3
- LVLDL - 10 - TR - XX - L3

TRIM RING FINISH  
 BK: Black, BZ: Bronze; BN - Brushed Nickel

## DIAGRAM

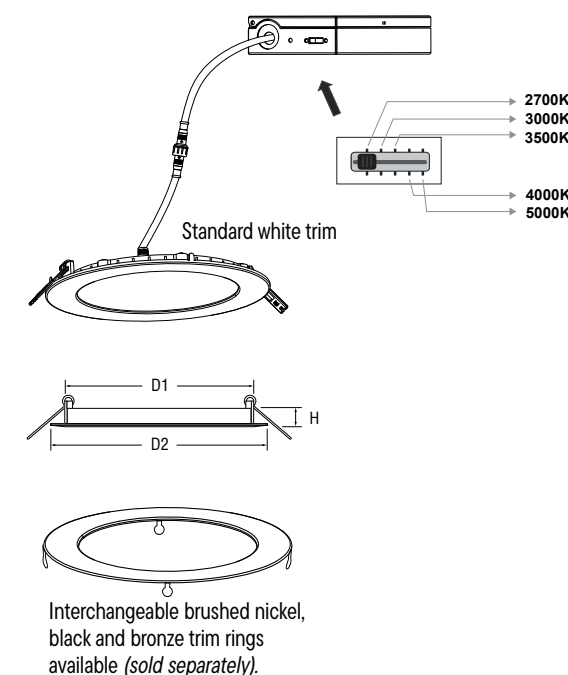

## ACCESSORIES



LVLDL-YY-TR-XX-L3  
 Trim Rings For 5 CCT LED Thin Line Down Light (sold separately).

## CONSTRUCTION PLATES

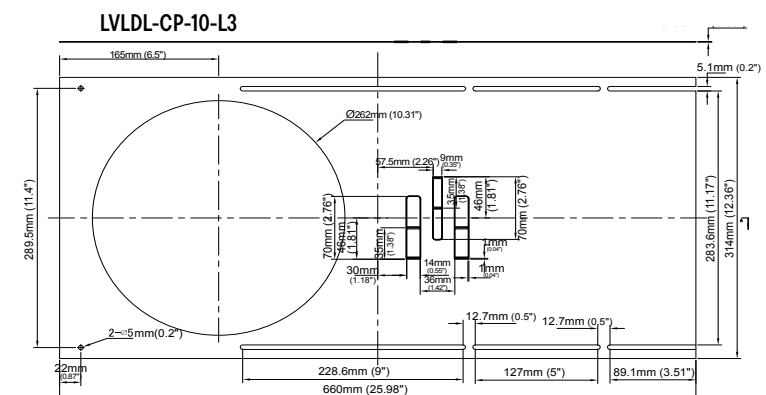
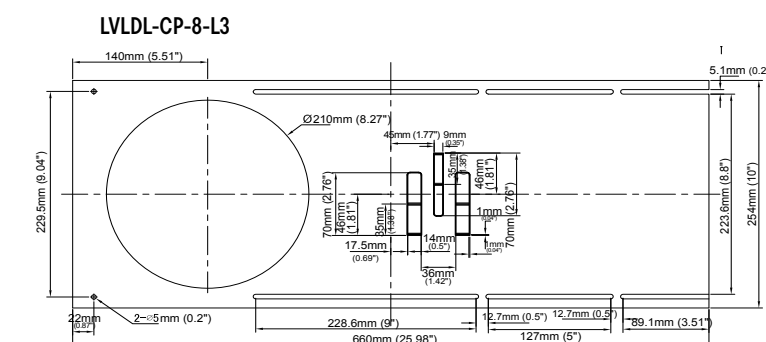
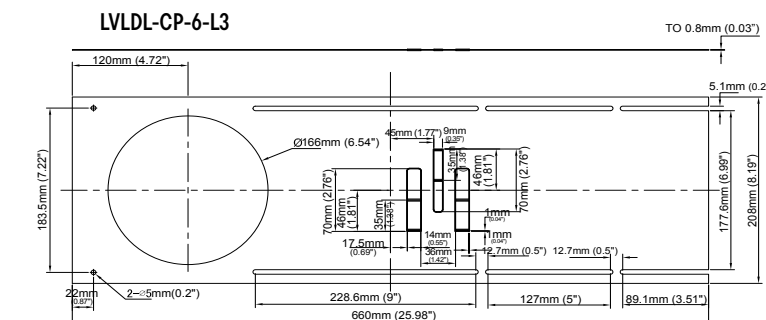
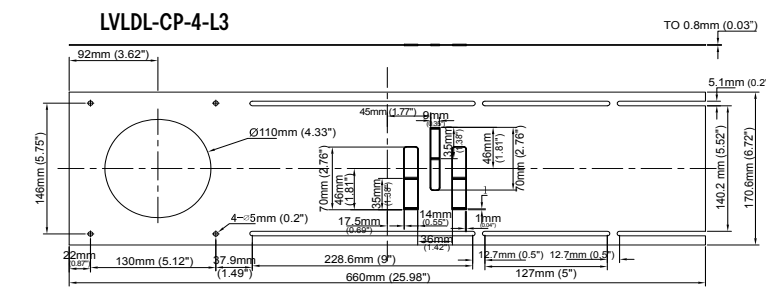
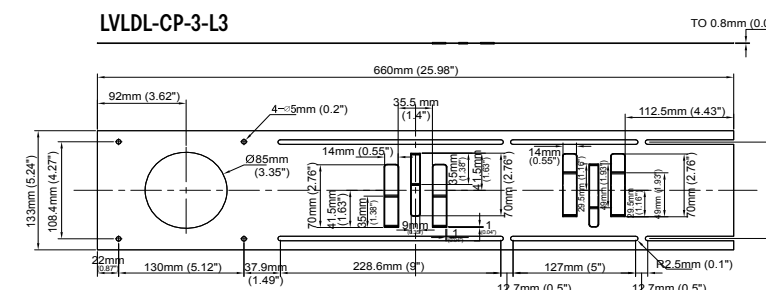

# 5CCT LED Thin Line Down Light (Square)

Designed with a sleek square shape, this down light offers versatility, affordability, and adjustable 5 color temperatures.



## FEATURES

- TRIAC dimmable
- 120° beam spread
- Adjustable colour temperature
- Two spring loaded clips to attach to any ceiling material
- White finish (interchangeable: brushed nickel, black, bronze trim rings available - sold separately)
- Wet locations listed
- Temperature rating: -20°C to 45°C
- No IC can required, for direct contact with insulation and combustible materials
- Connects directly to 120V power supply
- Optional 347V Step-Down Transformer (non-dimmable)

## APPLICATIONS

- Kitchens & pantries
- Laundry rooms
- Bathrooms
- Lobbies & hallways
- Banquet halls & elevators
- Retail lighting
- Offices & restaurants

## SPECIFICATIONS

		4 Inches	6 Inches
<b>Size</b>		4 Inches	6 Inches
<b>Product Code</b>		DL-5CCT-4S-WH	DL-5CCT-6S-WH
<b>Electrical</b>	Input Voltage	120V AC	
	Power Consumption	9W	12W
<b>Specs</b>	Color Temperature	2700/3000/3500/4000/5000K	
	Lumen Output	630	840
	Efficacy	70LM/W	
	CRI	90	
	Dimmable	Yes (TRIAC)	
	Beam Angle	120°	
<b>LED</b>	Type	Epistar	
	Life Span	50,000 Hours	
<b>Design</b>	Dimensions (Inches)	4.1 x 4.7 x .4"	6.3 x 6.8 x .4"
	Dimensions (Millimeters)	103 x 120 x 11.3mm	159 x 171.5 x 11.3mm
	Installation Hole Size	4.33" (110mm)	6.30" (160mm)
	Finish	White	
	Trim Finish	BK: Black, BZ: Bronze, BN:Brushed Nickel	
	Operating Temperature	-20°C to 45°C	
	Approved Location	Wet	
	Mounting	Ceiling	
<b>Warranty</b>	5 years		
<b>Approvals</b>	cETLus and Energy Star		

## PRODUCT CODES

DL-5CCT-YY-WH

5CCT LED Thin-Line Down Lights  
 SIZE (Square)  
 4S: 4"  
 6S: 6"

SQUARE TRIM RINGS (Sold Separately)

LVLDL - 04S - TR - XX - L3  
 LVLDL - 06S - TR - XX - L3

TRIM RING FINISH  
 BK: Black, BZ: Bronze; BN - Brushed Nickel

## DIAGRAM

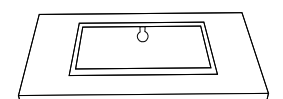
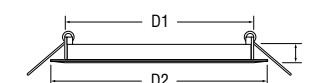
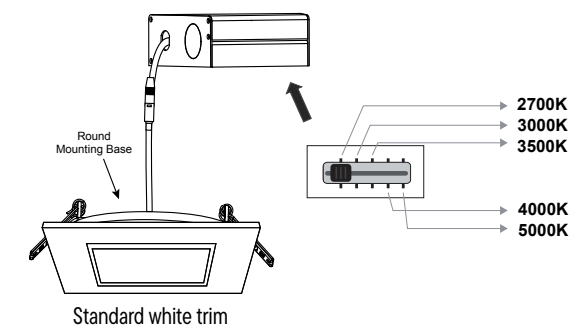

Interchangeable brushed nickel, black and bronze trim rings available (sold separately).

## ACCESSORIES

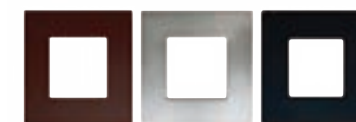

LVLDL-YY-S-TR-XX-L3  
 Square Shaped Trim Rings For 5 CCT LED Thin Line Down Light (sold separately).

## CONSTRUCTION PLATES

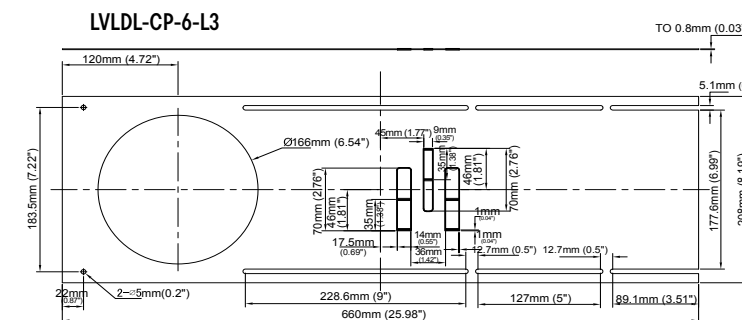
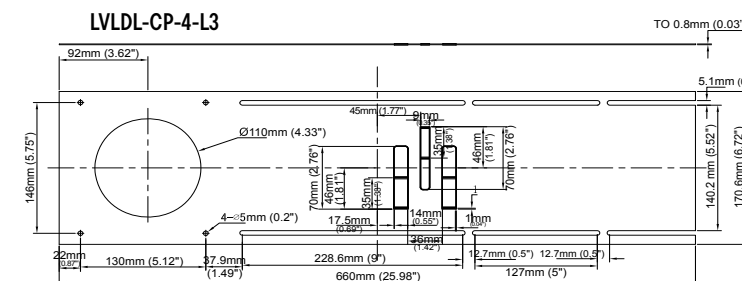

# Regressed Down Light (CCT)

Ideal for both new builds and remodeling projects, these versatile and cost-effective downlights come in two configurations: one allows to easily adjust the color temperature with a slider switch (2700/3000/4000K), while the other offers the flexibility of Bluetooth to select any color temperature from 2700K to 5000K.

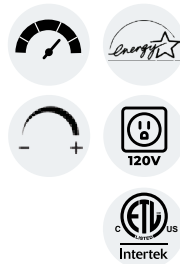

## FEATURES

- Two convenient options: Slider Switch CCT adjustable and Bluetooth CCT adjustable
- Dimmable: Slider Switch CCT Adjustable with Electronic Low Voltage (ELV) dimmers, and Bluetooth CCT Adjustable through the smartphone app
- Two spring loaded clips to attach to any ceiling material
- White finish; Interchangeable satin nickel, black and bronze trim rings available (sold separately)
- Bluetooth CCT Adjustable linkable up to 100 fixtures, individual and zonal control possible through the smartphone app
- Regressed design to reduce glare
- Suitable for damp locations
- Temperature rating: -20°C to 45°C
- The driver is wired for 120V input
- Optional 347V Step-Down Transformer
- 50,000 hour life
- 3 years limited warranty

## APPLICATIONS

- Lobbies
- Office lighting
- Hallways
- Under cabinet
- Banquet halls
- In cabinet
- Elevators
- Wall mount for regressed lighting
- Stairways
- Under soffits (outdoor)
- Retail
- Restaurants

## SPECIFICATIONS

Type	CCT Switch Adjustable		CCT Bluetooth Adjustable		
Product Code	RGL-4B-9W-SW (4")	RGL-6B-12W-SW (6")	RGL-4B-9W-BT (4")	RGL-6B-9W-BT (6")	
Electrical	Input Voltage	100-277V AC			
	Power Consumption	9W	12W	9W	12W
Specs	Color Temperature	2700/3000/4000K (Slider Switch CCT Adjustable)		2700-5000K (Bluetooth CCT Adjustable)	
	Lumen Output	630LM	840LM	630LM	840LM
	Efficacy	70LM/W			
	CRI	90+			
	Dimmable	Yes			
	Beam Angle	120°			
LED	Type	N/A			
	Life Span	50,000 Hours			
Design	Dimensions (Inches)	.86 x .511"	.86 x .716"	.86 x .511"	.86 x .716"
	Dimensions (Millimeters)	22 x 130mm	22 x 182mm	22 x 130mm	22 x 182mm
	Installation Hole Size	4.13" (105mm)	6.18" (157mm)	4.13" (105mm)	6.18" (157mm)
	Finish	White			
	Trim Finish	BK: Black, BZ: Bronze, SN: Satin Nickel			
	Operating Temperature	-20°C to 40°C			
	Approved Location	N/A			
Warranty	3 years				
Approvals	cETLus listed for damp locations and Energy Star				

## PRODUCT CODES

CCT SWITCH ADJUSTABLE  
RGL - 4B - 9W - SW  
RGL - 6B - 12W - SW

CCT BLUETOOTH ADJUSTABLE  
RGL - 4B - 9W - BT  
RGL - 6B - 12W - BT

TRIM RINGS  
(Sold Separately)  
RGL - 4 - TR - XX  
RGL - 6 - TR - XX

TRIM RING FINISH  
BK - Black  
BZ - Bronze  
SN - Satin Nickel

## STEP-DOWN TRANSFORMERS

DLT-347  
Step-down transformer 347/120V AC 25VA (non-dimmable)

DLT-60-347  
Step-down transformer 347/120V AC 60VA (non-dimmable)

DLT-100-347  
Step-down transformer 347/120V AC 100VA (non-dimmable)

## DIAGRAM

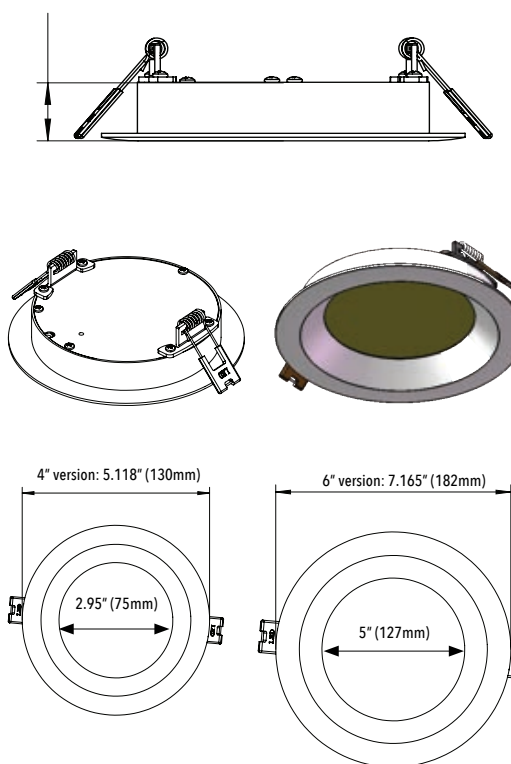

## CONSTRUCTION PLATES

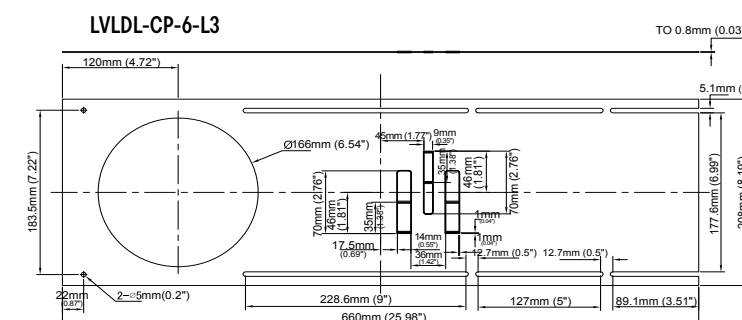
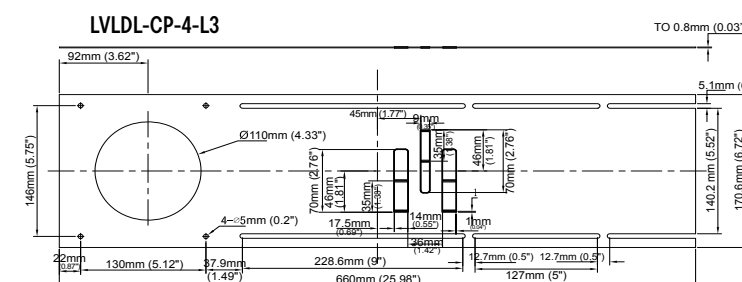

# 5CCT LED Gimbal Down Light

Ideal for directional lighting in both remodels and new constructions, 5CCT LED Gimbal Down Lights provide a flexible and cost-effective option across a broad range of uses.



## FEATURES

- 120V AC input voltage
- TRIAC dimmable
- Low power consumption: 8/ 14/18W
- Available in 3", 4" and 6"
- Luminous flux: 600-650LM/ 950-1000LM/ 1150-1200LM
- CCT adjustable: 2700/ 3000/ 3500/4000/ 5000K
- 30,000 hour life
- 360° rotation
- Beam angle: 38°
- Tilting angle: 90°
- 90CRI
- cETLus, Energy Star certified
- 5 years limited warranty
- Airtight

## APPLICATIONS

- |                    |                   |
|--------------------|-------------------|
| <b>RESIDENTIAL</b> | <b>COMMERCIAL</b> |
| • Kitchens         | • Lobbies         |
| • Pantries         | • Hallways        |
| • Laundry rooms    | • Elevators       |
| • Bathrooms        | • Stairways       |
|                    | • Retail          |
|                    | • Restaurants     |
|                    | • Office lighting |

## SPECIFICATIONS

Size	3 Inches	4 Inches	6 Inches
<b>Product Code</b>	GDL-3-8W-38-CCT-WH	GDL-4-14W-38-CCT-WH	GDL-6-18W-38-CCT-WH
<b>Electrical</b>	<b>Input Voltage</b> 120V AC		
	<b>Power Consumption</b> 8W	14W	18W
<b>Specs</b>	<b>Color Temperature</b> 2700/3000/3500/4000/5000K		
	<b>Luminous Flux</b> 600-650LM	950-1000LM	1150-1200LM
	<b>CRI</b> 90+		
	<b>Dimmable</b> Yes, TRIAC dimmable		
	<b>Beam Angle</b> 38°		
	<b>Rotation</b> 360°		
<b>LED</b>	<b>Type</b> High Brightness COB LED		
	<b>Life Span</b> 30,000 Hours		
<b>Design</b>	<b>Dimensions (Inches)</b> 1.3 x 3.35"	1.42 x 4.41"	2.09 x 6.02"
	<b>Dimensions (Millimeters)</b> 33 x 85mm	36 x 112mm	53 x 153mm
	<b>Installation Hole Size</b> 3 3/8" (85mm)	4 7/16" (112mm)	6" (153mm)
	<b>Finish</b> White		
	<b>Operating Temperature</b> N/A		
	<b>Approved Location</b> Indoor/Outdoor		
<b>Warranty</b>	5 years		
<b>Approvals</b>	cETLus and Energy Star		

## PRODUCT CODES

GDL - X - YY - 38 - CCT - WH

Gimbal Down Light	SIZE	Wattage	LED Colour
	3: 3"	8W (3")	2700K
	4: 4"	14W (4")	3000K
	6: 6"	18W (6")	3500K
			4000K
			5000K

## DIAGRAM

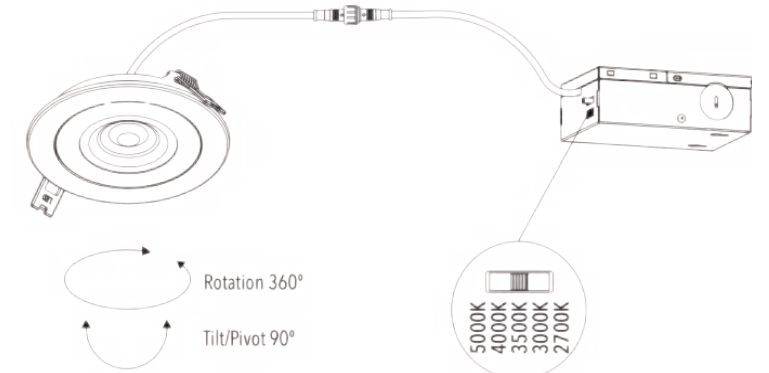

## DIMENSIONS

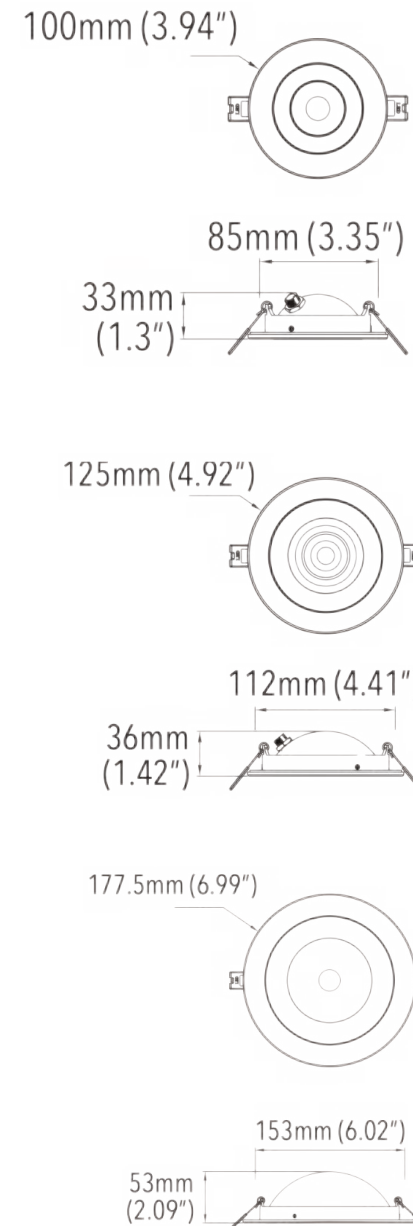

## CONSTRUCTION PLATES

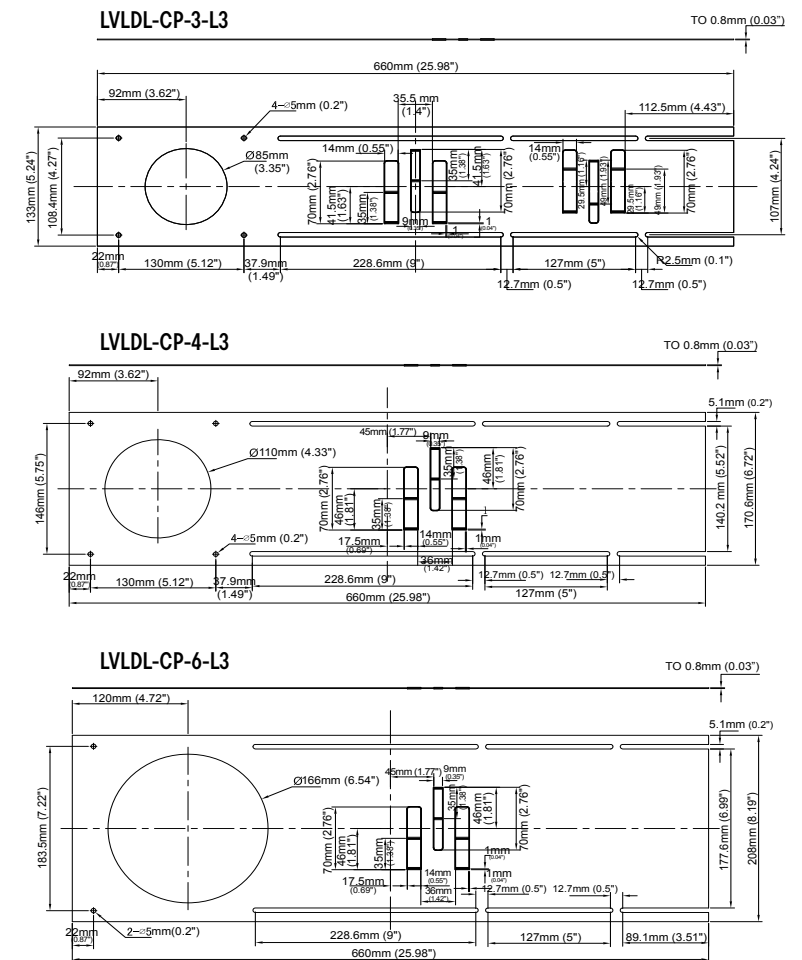

# Surface Mount Down Lights (ROUND)

The LED Surface Mount Down Light offers a streamlined solution for efficient lighting. Built-in Driver on Board (DOB) technology allows for easy ceiling installation without an external driver. Perfect for enhancing any residential or commercial space.



## FEATURES

- DOB technology provides a 120V alternating current source and eliminates the need for traditional LED driver
- Quick & easy to install on standard junction box, ceiling mount with mounting plate
- Temperature rating: -20° to 40°C
- Die-cast aluminum housing
- Smooth and continuous dimming with most ELV dimmers
- Rated for 50,000 hours
- No light bulbs to replace or dispose
- Instant full brightness (including in sub-zero temperatures)
- 80+ CRI
- cETLus listed for wet locations
- 5 years limited warranty

## APPLICATIONS

- |  |  |
|--|--|
| <b>RESIDENTIAL</b> <ul style="list-style-type: none"> <li>• Kitchens</li> <li>• Pantries</li> <li>• Laundry rooms</li> <li>• Under cabinet</li> <li>• In cabinet</li> <li>• Under soffits (Outdoor)</li> </ul> | <b>COMMERCIAL</b> <ul style="list-style-type: none"> <li>• Lobbies &amp; hallways</li> <li>• Banquet halls</li> <li>• Elevators &amp; stairways</li> <li>• Retail &amp; restaurants</li> <li>• Under cabinet</li> <li>• In cabinet</li> <li>• Wall mount for regress lighting</li> </ul> |
|--|--|

SPECIFICATIONS					
Size	6 Inches	8 Inches	10 Inches	12 Inches	
Product Code	LVLDL-SR-06-XX-WH-L	LVLDL-SR-08-XX-WH-L	LVLDL-SR-10-XX-WH-L	LVLDL-SR-12-XX-WH-L	
Electrical	Input Voltage: 120V AC				
	Power Consumption: 11W	14W	17W	22W	
Specs	Color Temperature: 3000/4000K				
	Lumen Output	880WW, 900NW	1000WW, 1050NW	1200WW, 1250NW	1800WW, 1850NW
	Efficacy	80WW, 82NW	71WW, 75NW	70WW, 73NW	82WW, 84NW
	CRI	80+			
	Dimmable	Yes (with most ELV dimmers)			
	Beam Angle	N/A			
LED	Type: Epistar				
	Life Span: 50,000 Hours				
Design	Dimensions (Inches)	6" D x 1" H	8" D x 1" H	10" D x 1" H	12" D x 1" H
	Dimensions (Millimeters)	152mm D x 25mm H	203mm D x 25mm H	254mm D x 25mm H	305mm D x 25mm H
	Product Material	Die-cast aluminum housing			
	Trim Finish	BK: Black, BZ: Bronze, BN: Brushed Nickel			
	Operating Temperature	-20°C to 40°C			
	Approved Location	Kitchens, pantries, laundry rooms, under soffits (outdoors)			
	Mounting	Surface			
	Warranty	5 years			
Approvals	cETLus listed for wet locations and Energy Star				

## PRODUCT CODES

LVLDL - SR - YY - XX - WH - L

Round LED Surface Mount Down Light	SIZE 06 - 6" 08 - 8" 10 - 10" 12 - 12"	LED Colour WW: 3000K NW: 4000K
------------------------------------	--	--------------------------------------

**ROUND TRIM RINGS (Sold Separately)**  
 LVLDL - SR - 06 - TR - XX - L  
 LVLDL - SR - 08 - TR - XX - L  
 LVLDL - SR - 10 - TR - XX - L  
 LVLDL - SR - 12 - TR - XX - L

**TRIM RING FINISH**  
 BK: Black, BZ: Bronze, SN: Satin Nickel

## DIAGRAM

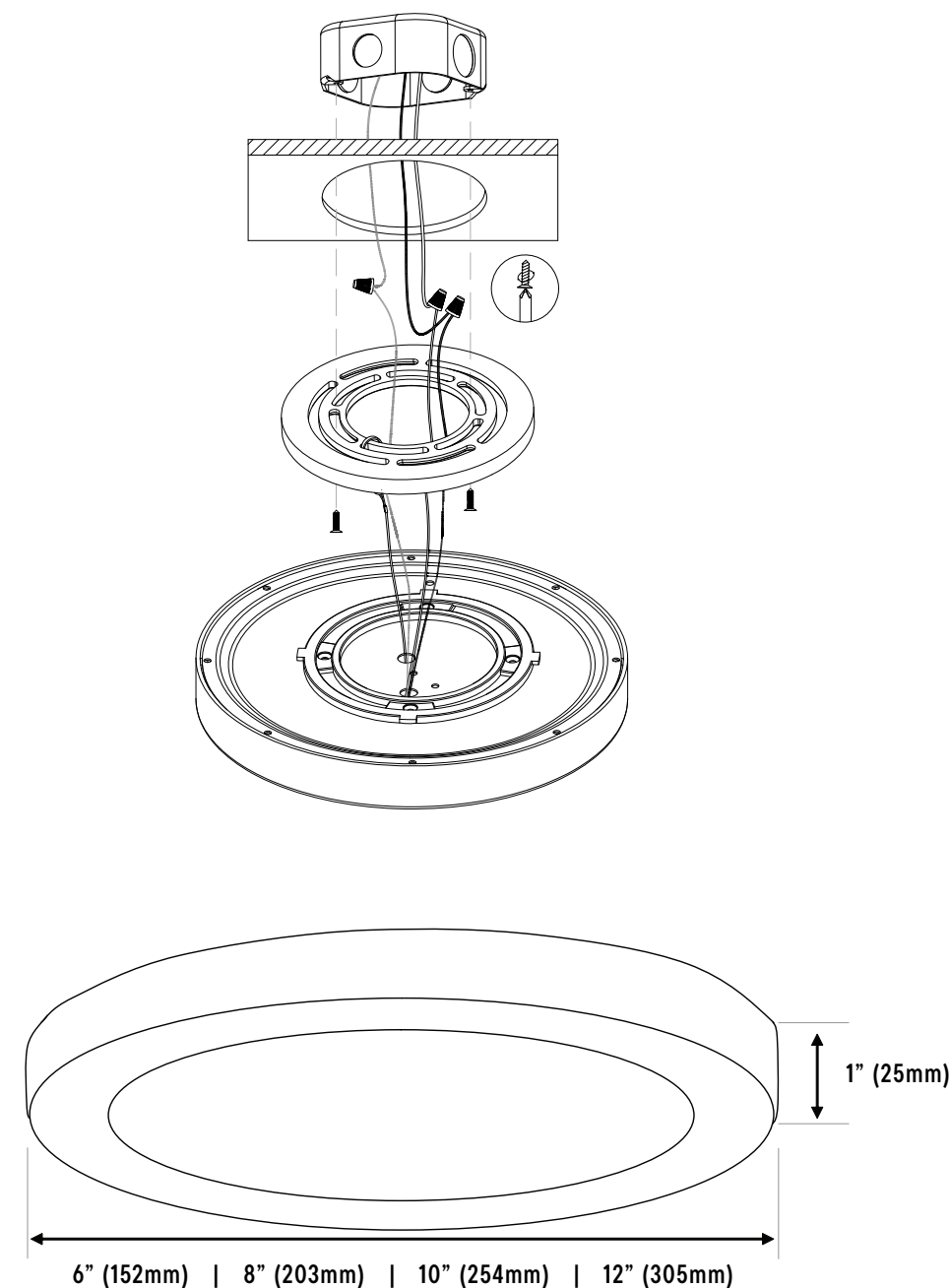

# Surface Mount Down Lights (SQUARE)

The Square LED Surface Mount Down Light, with its compact, square design and DOB technology, requires no external driver for ceiling mounting. Directly fits into 4" junction boxes, suitable for widespread lighting in residential or commercial spaces.



## FEATURES

- DOB technology provides a 120V alternating current source and eliminates the need for traditional LED driver
- Quick & easy to install on standard junction box, ceiling mount with mounting plate
- Temperature rating: -20° to 40°C
- Die-cast aluminum housing
- Smooth and continuous dimming with most ELV dimmers
- Rated for 50,000 hours
- No light bulbs to replace or dispose
- Instant full brightness (including in sub-zero temperatures)
- 80+ CRI
- cETLus listed for wet locations
- 5 years limited warranty

## APPLICATIONS

- |                    |                                   |
|--------------------|-----------------------------------|
| <b>RESIDENTIAL</b> | <b>COMMERCIAL</b>                 |
| • Kitchens         | • Lobbies & hallways              |
| • Pantries         | • Banquet halls                   |
| • Laundry rooms    | • Elevators & stairways           |
| • Under cabinet    | • Retail & restaurants            |
| • In cabinet       | • Under cabinet                   |
| • Under soffits    | • In cabinet                      |
| (Outdoor)          | • Wall mount for regress lighting |

SPECIFICATIONS				
Size	6 Inches	8 Inches	10 Inches	12 Inches
<b>Product Code</b>	LVLDL-SS-06-XX-WH-L	LVLDL-SS-08-XX-WH-L	LVLDL-SS-10-XX-WH-L	LVLDL-SS-12-XX-WH-L
<b>Electrical</b>	120V AC			
Input Voltage	120V AC			
Power Consumption	11W	14W	17W	22W
<b>Specs</b>	3000/4000K			
Color Temperature	3000/4000K			
Lumen Output	880WW, 900NW	1000WW, 1050NW	1200WW, 1250NW	1800WW, 1850NW
Efficacy	80WW, 82NW	71WW, 75NW	70WW, 73NW	82WW, 84NW
CRI	80+			
Dimmable	Yes (with most ELV dimmers)			
Beam Angle	N/A			
<b>LED</b>	Epistar			
Type	Epistar			
Life Span	50,000 Hours			
<b>Design</b>	Die-cast aluminum housing			
Dimensions (Inches)	6" D x 1" H	8" D x 1" H	10" D x 1" H	12" D x 1" H
Dimensions (Millimeters)	152mm D x 25mm H	203mm D x 25mm H	254mm D x 25mm H	305mm D x 25mm H
Product Material	Die-cast aluminum housing			
Trim Finish	BK: Black, BZ: Bronze, BN: Brushed Nickel			
Operating Temperature	-20°C to 40°C			
Approved Location	Kitchens, pantries, laundry rooms, under soffits (outdoors)			
Mounting	Surface			
<b>Warranty</b>	5 years			
<b>Approvals</b>	cETLus listed for wet locations and Energy Star			

## PRODUCT CODES

LVLDL - SS - YY - XX - WH - L

Square LED Surface Mount Down Light

SIZE  
06 - 6"  
08 - 8"  
10 - 10"  
12 - 12"

LED Colour  
WW: 3000K  
NW: 4000K

**ROUND TRIM RINGS (Sold Separately)**  
LVLDL - SS - 06 - TR - XX - L  
LVLDL - SS - 08 - TR - XX - L  
LVLDL - SS - 10 - TR - XX - L  
LVLDL - SS - 12 - TR - XX - L

**TRIM RING FINISH**  
BK: Black, BZ: Bronze, SN: Satin Nickel

## DIAGRAM

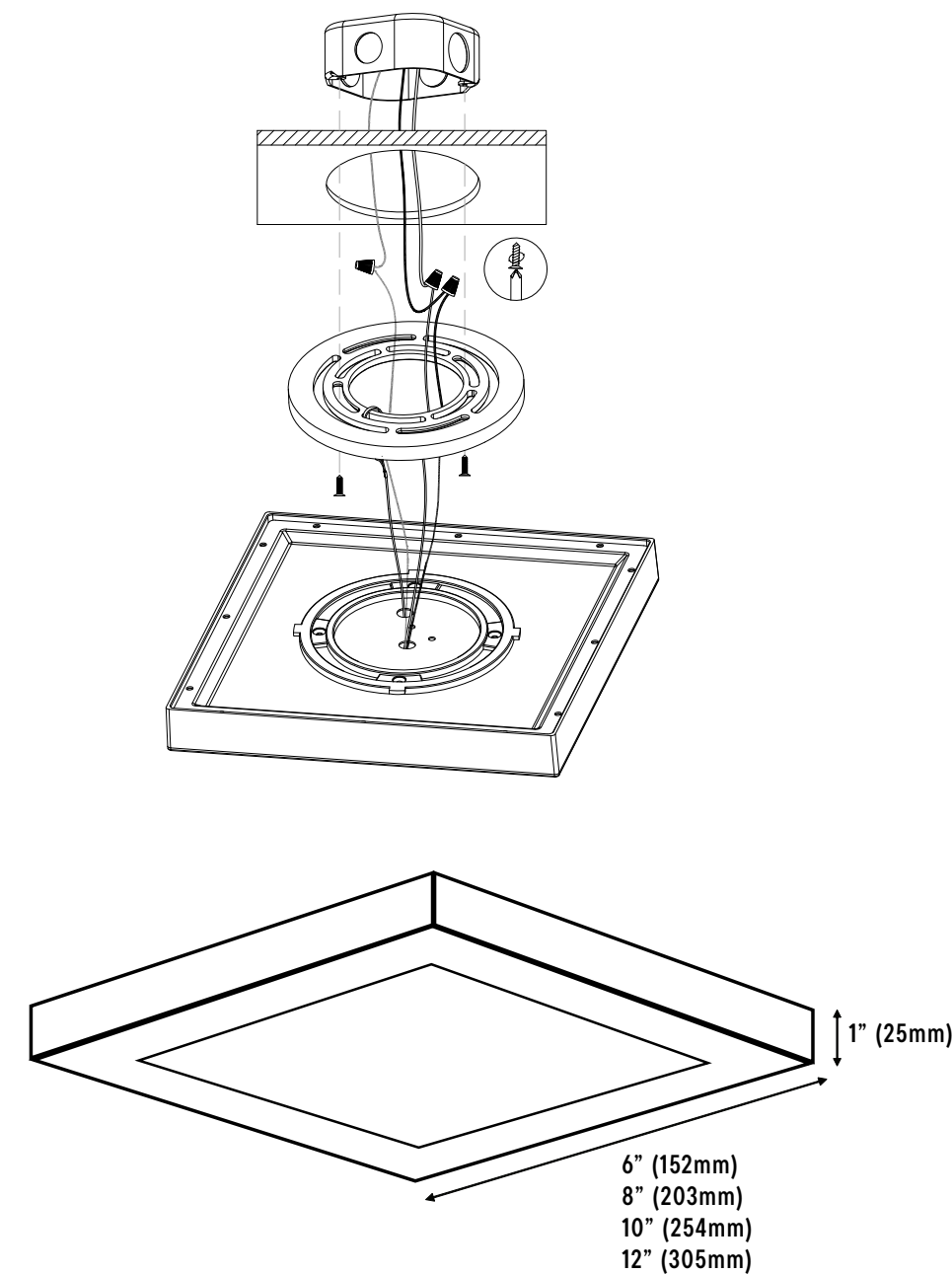

# Ceiling Lights

Ceiling lights are versatile, designed to fit any interior, whether at home or in a business. They serve as direct replacements for traditional ceiling fixtures, offering both aesthetic appeal and energy efficiency.

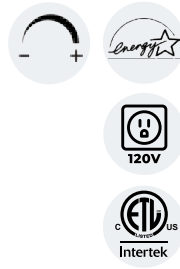

## FEATURES

- Elegant and energy efficient design
- Available in brushed nickel trim
- Suitable for damp location
- Input voltage: 120VAC
- Dimmable with most ELV dimmers
- 50,000 hours life
- cETLus listed
- Easy installation
- Maintenance free
- Even light distribution
- 5 year warranty

## APPLICATIONS

- |                    |                        |
|--------------------|------------------------|
| <b>RESIDENTIAL</b> | <b>COMMERCIAL</b>      |
| • Kitchens         | • Lobbies              |
| • Pantries         | • Hallways             |
| • Laundry rooms    | • Elevators            |
| • Bathrooms        | • Stairways            |
|                    | • Retail & restaurants |

## SPECIFICATIONS

<b>Product Code</b>	CLD-1625-XXK-BN	
<b>Electrical</b>	<b>Input Voltage</b>	120V AC
	<b>Power Consumption</b>	25W
<b>Specs</b>	<b>Colour Temperature</b>	3000K
	<b>CRI</b>	80
	<b>Lumen Output</b>	1875LM
	<b>Dimmable</b>	Yes (with most ELV dimmers)
	<b>Beam Angle</b>	N/A
<b>LED</b>	<b>Type</b>	N/A
	<b>Life Span</b>	50,000 Hours
<b>Design</b>	<b>Dimensions (Inches)</b>	18.87 x 3.65"
	<b>Dimensions (Millimeters)</b>	403 x 93mm
	<b>Finish Colour / Trims</b>	Brushed Nickel
	<b>Product Material</b>	Metal/Acrylic
	<b>Operating Temperature</b>	N/A
	<b>Approved Location</b>	Indoor
	<b>Mounting</b>	Ceiling
<b>Warranty</b>	5 years	
<b>Approvals</b>	cETLus and Energy Star	

NOTE: MOQ may apply.

## PRODUCT CODES

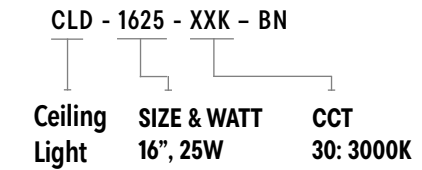

## DIAGRAM

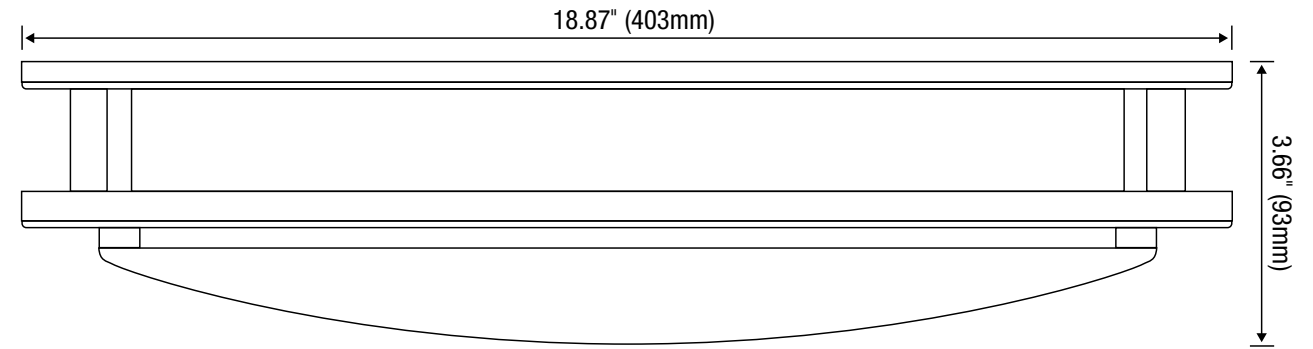

# Wall Sconce

Beautifully designed, elegant and a great addition to any decor, Wall Sconces will compliment any designer look. These fixtures can replace any existing indoor accent lighting, creating tremendous energy savings, at an extremely affordable price.

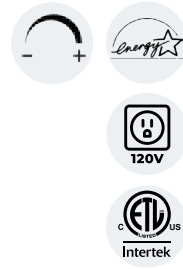

## FEATURES

- Elegant and energy efficient design
- Brushed nickel trim finish
- Input voltage 120V AC
- Dimmable with most ELV dimmers
- 50,000 hours life
- Suitable for damp location
- cETLus listed
- Easy installation
- Maintenance free
- Even light distribution
- 5 years warranty

## APPLICATIONS

- Hallways
- Lobbies
- Banquet halls
- Retail
- Restaurants

## SPECIFICATIONS

Product Code	WSL-15-XXK-BN	
Electrical	Input Voltage	120V AC
	Power Consumption	15W
Specs	Colour Temperature	3000K
	CRI	80+
	Lumen Output	1600LM
	Dimmable	Yes (with most ELV dimmers)
	Beam Angle	N/A
LED	Type	N/A
	Life Span	50,000 Hours
Design	Dimensions (Inches)	9.45 x 10.63"
	Dimensions (Millimeters)	240.03 x 270mm
	Finish Colour / Trims	Brushed Nickel
	Product Material	N/A
	Operating Temperature	N/A
	Approved Location	Indoor
	Mounting	Wall
Warranty	5 years	
Approvals	cETLus and Energy Star	

## PRODUCT CODES

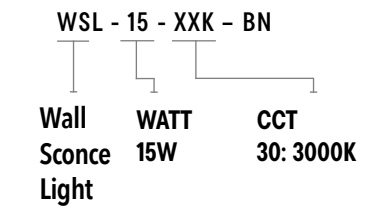

## DIAGRAM

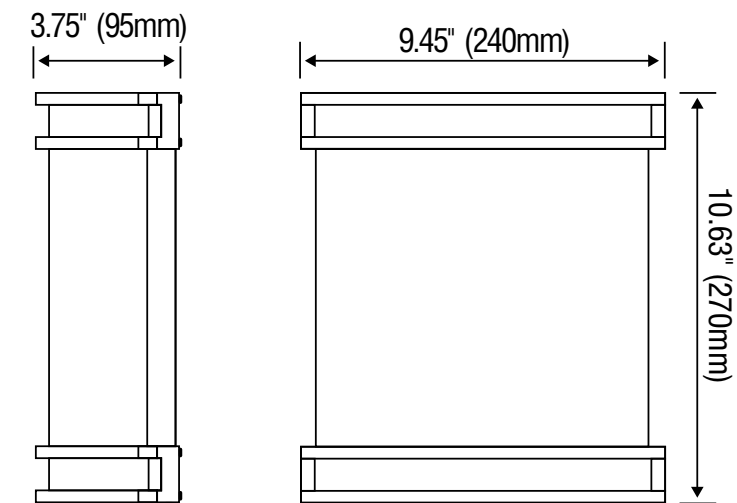



# T-Edge Lights (5CCT)

An innovative lighting solution, ideal for general and accent lighting in offices, hallways, and commercial applications. Its edge-lit design and 5CCT feature ensure versatile illumination, moving beyond traditional flat panels and troffers.

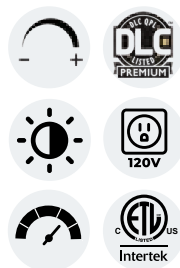

## FEATURES

- Ideal replacement for traditional flat panel and troffers
- Non-flicker, no dark spots
- IP Rating: IP40
- cETLus and DLC premium listed
- Dry locations
- 5 year limited warranty

## APPLICATIONS

- |                    |                   |
|--------------------|-------------------|
| <b>RESIDENTIAL</b> | <b>COMMERCIAL</b> |
| • Kitchens         | • Retail          |
| • Bathrooms        | • Offices         |
| • Laundry rooms    | • Hallways        |
| • Pantries         | • Elevators       |
| • Rec rooms        | • Banquet halls   |
|                    | • Restaurants     |

## SPECIFICATIONS

Product Code		TLE-2X2-K40-3065	TLE-2X4-K60-3065
Electrical	Input Voltage	100-277V AC	
	Power Consumption	20/30/40W Adjustable	40/50/60W Adjustable
Specs	Colour Temperature	3000/3500/4000/5000/6500K	
	CRI	80+	
	Lumen Output	2200-5200LM	4400-7800LM
	Efficacy (LM/W)	N/A	
	Dimmable	0-10V Dimming	
	Beam Angle	120°	
LED	Type	N/A	
	Life Span	50,000 Hours	
Design	Dimensions (Inches)	23.74 x 23.74 x 0.59"	23.74 x 47.76 x 0.59"
	Dimensions (Millimeters)	603 x 603 x 15mm	603 x 1213 x 15mm
	Finish	N/A	
	Housing Material	6063-T5	
	Operating Temperature	-20°-45°C	
	Approved Location	Dry	
Mounting	Ceiling		
Warranty	5 years		
Approvals	cETLus and DLC Premium		

## PRODUCT CODES

TLE - 2X2 - K40 - 3065  
TLE - 2X4 - K60 - 3065

SIZE                  WATTS

## DIAGRAM

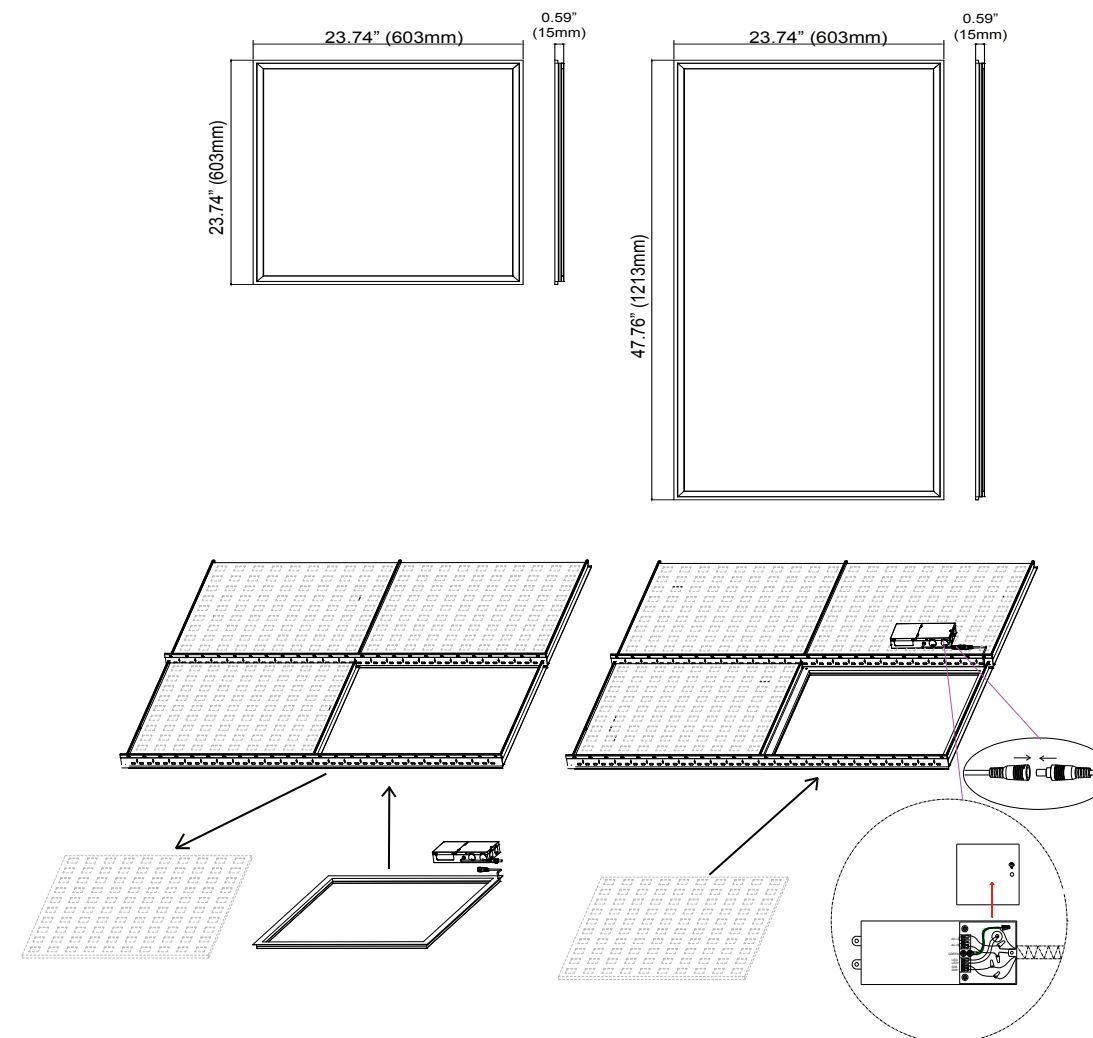

## ACCESSORIES

- |   |   |   |
|---|---|---|
|   |   |   |
| <b>TLE-DM</b><br>Driver mount bracket (for mounting the bracket to the T-BAR) | <b>TLE-MC</b><br>Mounting clips (for fixture wire suspension) | <b>ELP14-2060-UNV</b><br>Emergency Driver (sold separately) |

## NOTES:

- TLE-EX-CCT-10: T-LED CCT Edge Light Extension Cord. 10ft is available.
- Driver mount bracket (TLE-DM), and mounting clips (TLE-MC) are available (sold separately). Please check your local building codes, if these accessories.

# 5CCT Fire Rated Thin Line

Designed to seamlessly merge into any environment, these fixtures combine sleek aesthetics with top-tier fire-resistant materials, ensuring not only captivating illumination but also adherence to stringent safety standards. Illuminate spaces with confidence, knowing you've chosen the best in style and safety.



## FEATURES

- 2 hour fire rated: UL 263, ASTM E119 & CAN/ULC S101-14
- Two spring loaded clips to attach to any ceiling material
- White finish (interchangeable brushed nickel, black, oil-rubbed bronze, and copper trim rings available – sold separately)
- Wet locations listed
- No IC can required, for direct contact with insulation and combustible materials
- Optional 347V step-down
- 5 year limited warranty
- Airtight
- cETLus and Energy Star listed
- Comes with mounting brackets and end-to-end connector

## APPLICATIONS

- Kitchens & pantries
- Laundry rooms
- Bathrooms
- Lobbies & hallways
- Banquet halls
- Elevators
- Retail lighting
- Offices & restaurants

## SPECIFICATIONS

Product Codes		DL-FR-5CCT-4-WH	DL-FR-5CCT-6-WH
Electrical	Input Voltage	120V AC	
	Output Power (W)	12W	15W
Specs	Colour Temperature	5-position switch for colour temperature adjustment: 2700/3000/3500/4000/5000K	
	CRI	90+	
	Lumens	800LM	1100LM
	Efficacy (LM/W)	N/A	
	Dimmable	Yes, with TRIAC dimmers	
	Beam Angle	120°	
LED	Type	Epistar	
	Life Span	50,000 Hours	
	Spacing	N/A	
	# per foot / unit	N/A	
Design	Dimensions (Inches)	D1=3", D2=5", H=1/2"	D1=5", D2=7", H=1/2"
	Dimensions (Millimeters)	D1=81mm, D2=127mm, H=11.5mm	D1=126mm, D2=175mm, H=11.5mm
	Finish	White finish	
	Trim Ring (Finish)	Brushed nickel, black, oil-rubbed bronze, and copper trim rings – Sold separately	
	Max Single Run Length	N/A	
	Custom Cuttable	N/A	
	Operating Temperature	-20° to +45°C	
	Approved Location	Wet	
	Mounting	Ceiling	
Warranty	5 years		
Approvals	cETLus and Energy Star		



## DIAGRAM

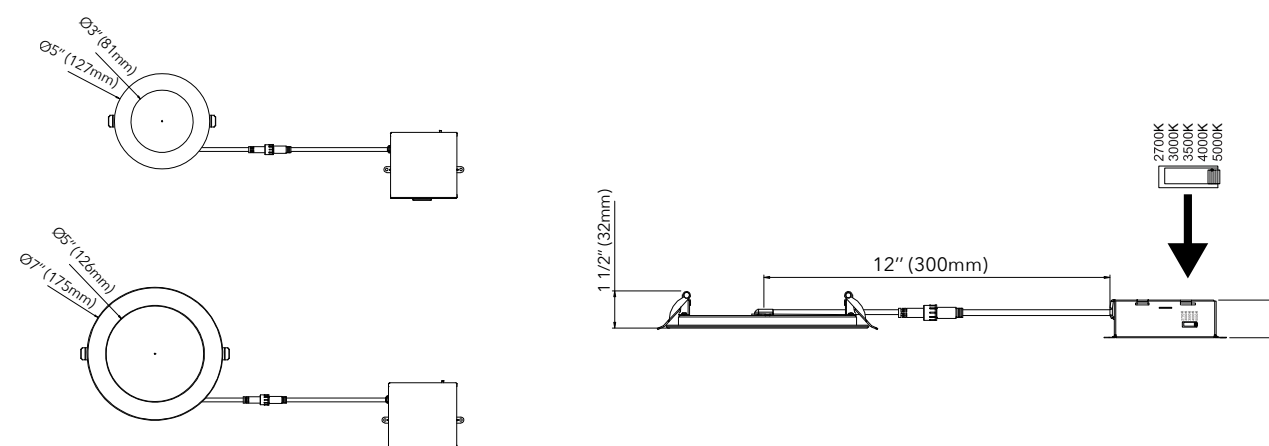

## ACCESSORIES



- DL-FR-TR-4-YY**  
TRIM RINGS  
YY=  
• BK (Black)  
• BZ (Oil Rubbed Bronze)  
• BN (Brushed Nickel)  
• CP (Copper)



- DL-FR-TR-6-YY**  
TRIM RINGS  
YY=  
• BK (Black)  
• BZ (Oil Rubbed Bronze)  
• BN (Brushed Nickel)  
• CP (Copper)



- DL-FR-BR-4**  
BEAUTY RINGS



- DL-FR-BR-6**  
BEAUTY RINGS



- DL-FR-CP-4**  
CONSTRUCTION PLATES



- DL-FR-CP-6**  
CONSTRUCTION PLATES



# Industrial Lighting

# Tri-Proof Lights

Tri-Proof Lights are robust and stylish, designed to withstand impacts, dust, and water, making them suitable for tough environments like factories and garages, as well as residential areas like stairwells and hallways.



## FEATURES

- Water-proof (IP66), dust-proof, pressure-proof (IK10)
- Luminous Efficacy (LPW): 110-120
- Available in 4 ft. length / 40W version
- Excellent heat dissipation
- 50,000 hours life
- Energy efficient: Up to 80% energy savings
- Vandal resistant
- cETLus listed
- 5 years limited warranty

## APPLICATIONS

- Parking garages
- Tunnels
- Airports
- Exhibition halls
- Railway, bus and subway stations
- Warehouses and factories
- Supermarkets
- Schools

## SPECIFICATIONS

Product Code		SL66-4FT-40W-40
Electrical	Input Voltage	100-240V/277V
	Power Efficiency	90%
Specs	Colour Temperature	4000K
	CRI	80+
	Luminous Efficacy	110-120LM/W
	Dimmable	N/A
	Beam Angle	120°
LED	Type	High brightness SMD2835
	Life Span	N/A
Design	Dimensions (Inches)	48 x 3.7 x 2.7"
	Dimensions (Millimeters)	1200 x 94 x 69mm
	Operating Temperature	-22°F to 113°F (-30°C to 45°C)
	Approved Location	Indoor/Outdoor
	Mounting	N/A
Warranty		5 years
Approvals		cETLus

NOTE: Each fixture ships with two strain relief connectors.

## PRODUCT CODES

SL66 - 4FT - 40W - XX

Tri-Proof Light

LED COLOUR

40: 4000K

## DIAGRAM

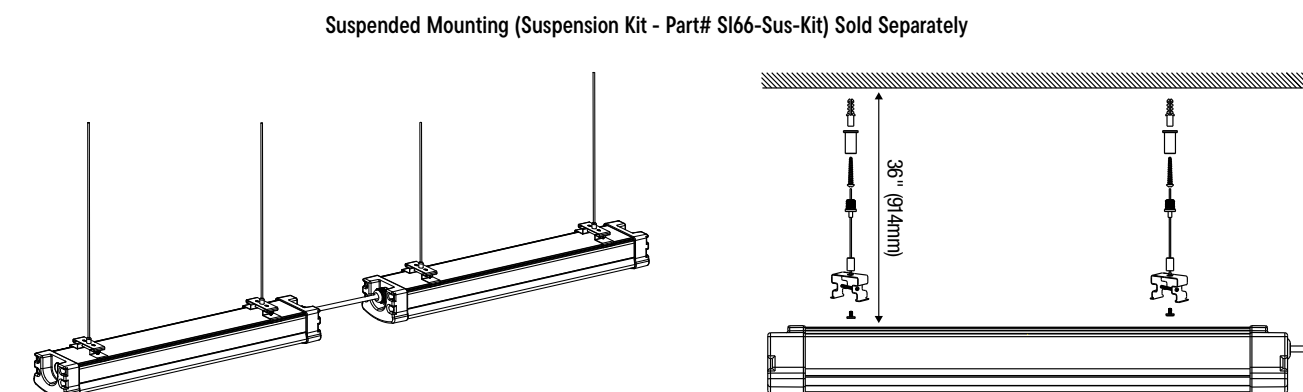
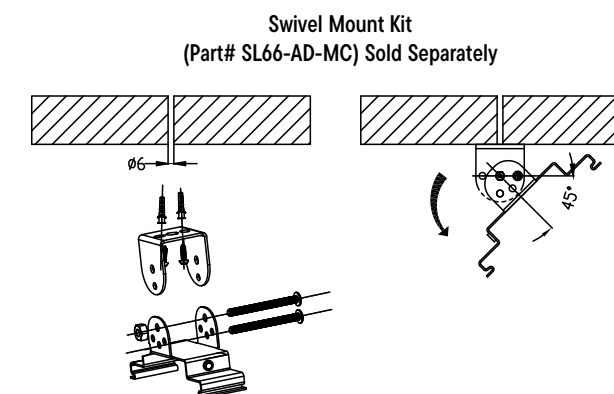
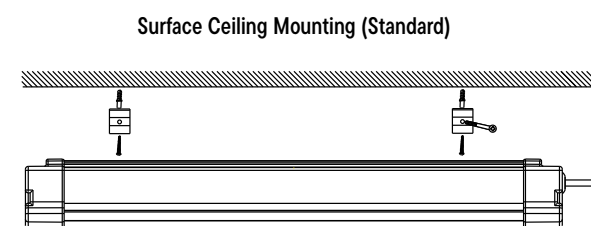
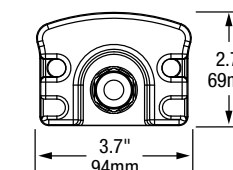

# 100W LED Work Light

The LED Work Light is an energy savings, impact resistant long life temporary lighting solution for illuminating workplaces, shops, garages, and warehouses.



## FEATURES

- Spring loaded hook
- 10ft power cord with plug
- 6KV/10KV surge protection
- Hidden, built-in hidden socket
- Eye-catching housing
- Stainless steel guard
- Epistar LEDs
- Hollow heat sink
- Silicone gaskets for damp location use
- 5 years limited warranty

## APPLICATIONS

- Construction sites
- Machinery illumination
- Automotive garages
- Industrial warehouses
- Repair shops
- Outdoor night projects

## SPECIFICATIONS

Product Code		LWL-100W-50
Electrical	Input Voltage	120V AC, 50-60Hz
	Power Consumption	60W
Specs	Colour Temperature	5000K
	CRI	80+
	Lumen Output	7200
	Efficacy	120 LM/W
	Beam Angle	360°
LED	Type	Epistar 2835
	Life Span	50,000 Hours
	# per foot / unit	408
Design	Dimensions (Inches)	6.5 x 11.5"
	Dimensions (Millimeters)	165 x 292mm
	Finish Colour / Trims	Black, yellow
	Product Material	Stainless steel guard
	Max Single Run Length	10 LED work lights
	Operating Temperature	N/A
	Approved Location	Damp
	Mounting	Optional tripod, floor mount, magnet mount accessories
Warranty	5 years	
Approvals	cULus, listed for damp location	

## PRODUCT CODES

LWL - 100W - 50

## DIAGRAM

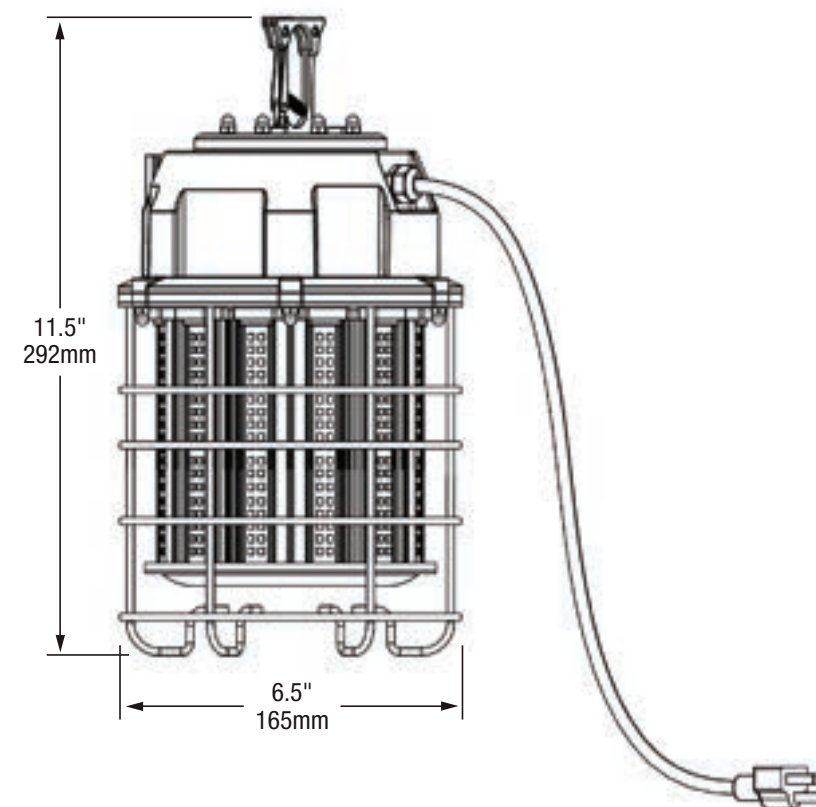

## ACCESSORIES



**LWL-MM**  
Magnet mount kit

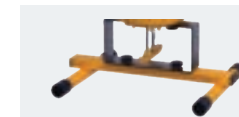

**LWL-FM**  
Floor mount kit

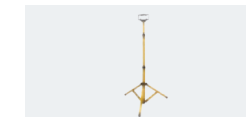

**LWL-TM**  
Tripod mount kit

# 60W LED Work Light

The 60W LED Work Light offers energy-saving, impact-resistant, long-life, temporary lighting solutions for illuminating construction sites, shops, garages, and warehouses.



PRODUCT CODES

LWL - 60W - 50

DIAGRAM

FEATURES

- 5ft power cord with plug
- Lumen output: 7200LM
- Built-in hidden socket
- Up to 10 LED Work Lights per 120V AC tap
- Stainless steel guard
- LED colour: 5000K
- Damp locations
- 5 years limited warranty
- Optional tripod, floor mount and magnet mount accessories

APPLICATIONS

- Construction sites
- Workshops
- Garages
- Warehouses
- Outdoor night projects
- Emergency repair situations

SPECIFICATIONS

Product Code	LWL-60W-50	
Electrical	Input Voltage	120V AC, 50-60Hz
	Power Consumption	60W
Specs	Colour Temperature	5000K
	CRI	80+
	Lumen Output	7200
	Efficacy	120 LM/W
	Beam Angle	360°
LED	Type	Epistar 2835
	Life Span	50,000 Hours
	# per foot / unit	408
Design	Dimensions (Inches)	5.12"W x 10.4"H
	Dimensions (Millimeters)	130mm x 215mm
	Finish Colour / Trims	Black, yellow
	Product Material	Stainless steel guard
	Max Single Run Length	10 LED work lights
	Operating Temperature	N/A
	Approved Location	Damp
Mounting	Optional tripod, floor mount, magnet mount accessories	
Warranty	5 years	
Approvals	cETLus and DLC	

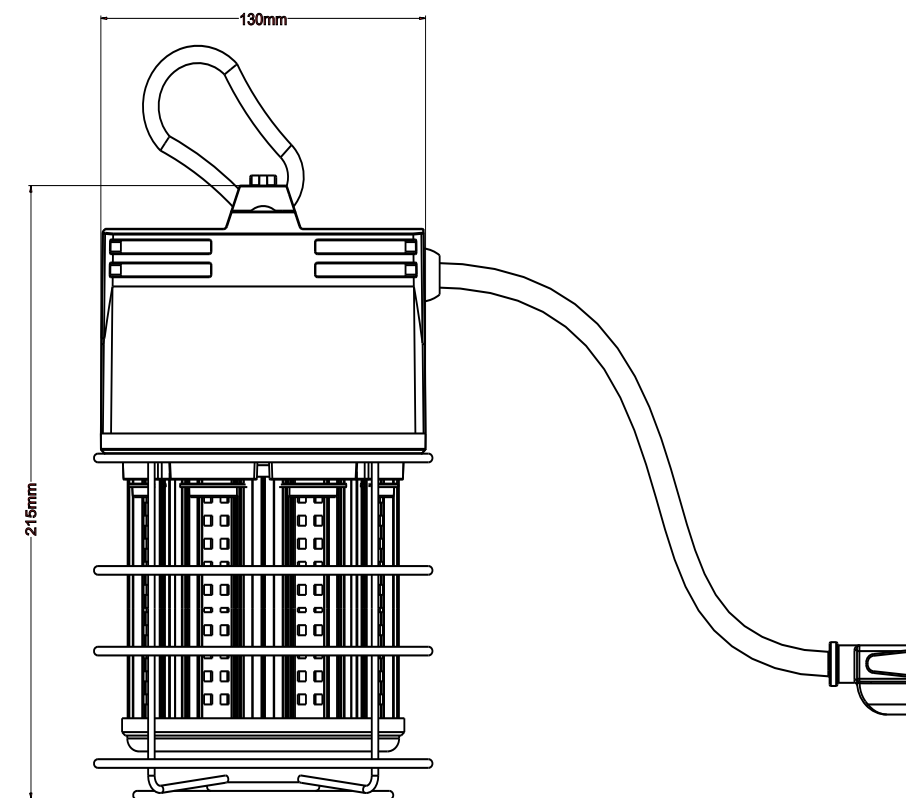

# LED String Work Light

The LED String Work Light features 5 x 8-watt LED fixtures along a 50Ft string, offering bright, efficient, and portable lighting for construction sites, shops, garages, or warehouses.



## FEATURES

- Length: 50ft
- Lumen output: 5000LM
- Wet locations
- LED colour: 5000K
- 40 Watts per string
- Up to 10 LED string work lights per 120V AC tap

- Metal wire guard around each fixture
- Carabiner clip on each fixture
- 5 years limited warranty

## APPLICATIONS

- Construction sites
- Outdoor events
- Workshops
- Garages
- Warehouses
- Marinas

## SPECIFICATIONS

Product Code		SWL-40W-50
Electrical	Input Voltage	120V AC, 50-60Hz
	Power Consumption	60W
Specs	Colour Temperature	5000K
	CRI	80+
	Lumen Output	7500
	Efficacy	112.5 LM/W
	Beam Angle	N/A
LED	Type	N/A
	Life Span	50,000 Hours
	Spacing	1500mm (59 1/16") at start/finish, 4 x 3000mm (118 7/64")
	# per foot / unit	5
Design	Dimensions (Inches)	4.5" W x 3" H
	Dimensions (Millimeters)	112 x 78mm
	Finish Colour / Trims	Yellow
	Product Material	N/A
	Max Single Run Length	50Ft
	Operating Temperature	N/A
	Approved Location	Wet
Mounting	Carabiner clip	
Warranty	5 years	
Approvals	cETLus	

## PRODUCT CODES

SWL - 40W - 50

## DIAGRAM

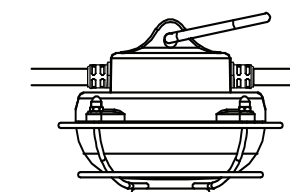
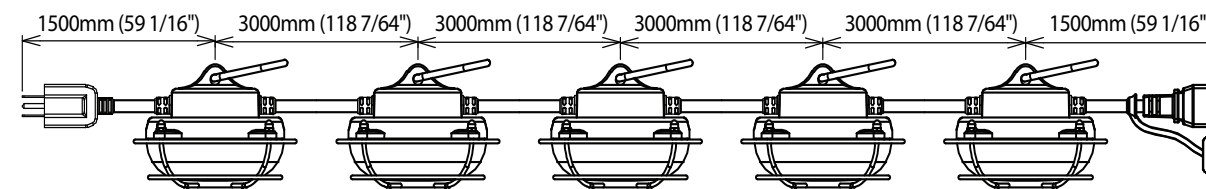



# **Drivers & Controllers**



# Switchex®

## LED DRIVER + DIMMER IN ONE

SWITCHEX® is a dimmer with an integrated driver that converts 120VAC to either 12VDC or 24VDC. This means SWITCHEX® is all you need between your line voltage and low voltage LED lighting. Best of all, it fits in a standard electrical box.

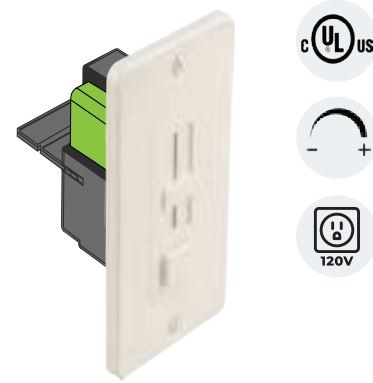

SWITCHEX® solves two of the most common LED lighting challenges:

- Poor dimming performance that often results when a dimmer and LED driver are made by different manufacturers
- Finding a place to fit the LED driver



### FEATURES

- First LED Driver + In-Wall Dimmer Switch in one unit
- Simplifies LED installation by eliminating compatibility issues between driver and dimmer
- Fits in a standard recessed electrical box
- 100% - 1% smooth dimming
- No minimum load
- Single pole preset dimmer with on/off push switch
- Adjustable voltage output dial to address voltage drop
- Includes voltage barrier partition to install high and low voltage circuit in same switch box
- No derating required when ganging units
- Power failure memory: If power is interrupted, SWITCHEX will return to setting prior to interruption

### APPROVED FIXTURES

- 24V LED Fixtures
- HP strip series
  - eStrip
  - Globe light
  - Hard strip
- 12V LED Fixtures
- Disc light

### SPECIFICATIONS

Product Code		SX-12V-DD-60W	SX-24V-DD-100W
Electrical	Input Voltage	120V AC	
	Output Voltage	12V DC	24V DC
Specs	Max. Load	60W, 5A	100W, 4.2A
	Power Factor	>0.9 @ 120VAC 60Hz max load	
	Efficiency	≥91% @ 120VAC max load	
	Dimmable	Yes	
	Protections	Short circuit, thermal runaway, and over voltage	
	Mounting	Single-Gang Box	
	Connection Type	Hardwire	
Warranty	2 years		
Approvals	cULus, FCC, RoHS		

### PRODUCT CODES

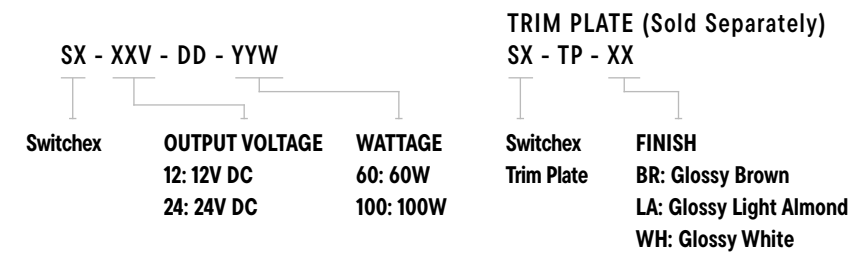

### DIAGRAM

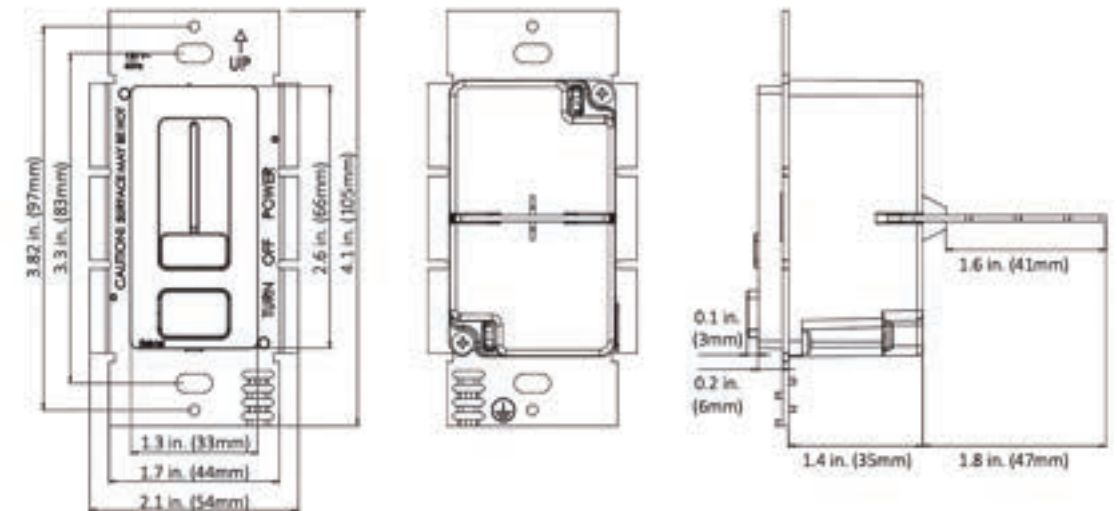
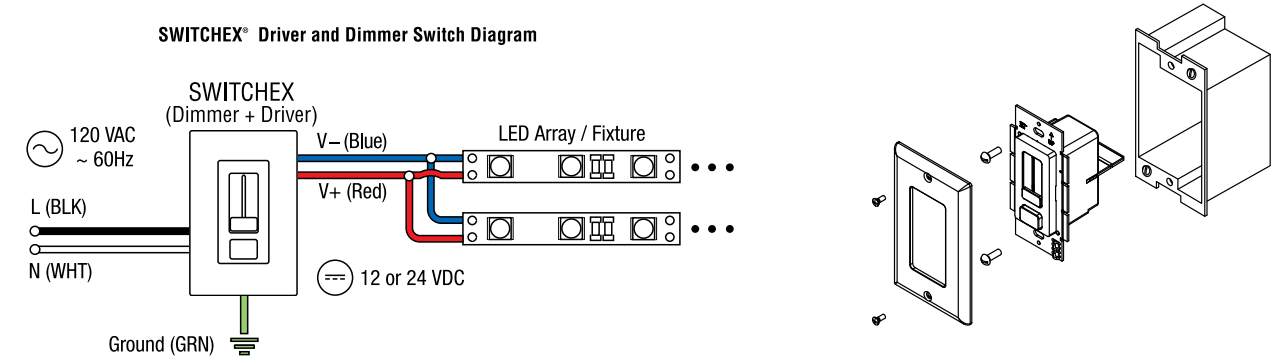

### The Driver Is Inside

SWITCHEX® is all you need between your line voltage and low voltage LED lighting. The integrated driver converts 120VAC to either 12VDC or 24VDC and it fits in a standard electrical box.

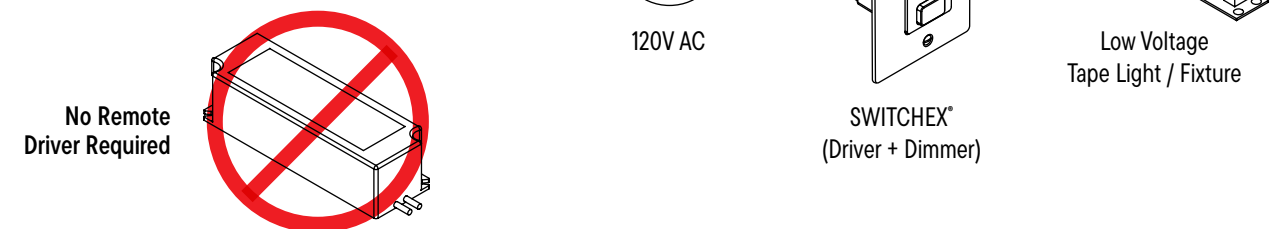

# Dimmable Driver/Dimmer Compatibility List

Our dimmable LED drivers offer smooth brightness control, letting you adjust your LED lighting from fully lit (100%) to completely off (0%). These drivers are Class 2 certified and built to work with the majority of standard Magnetic Low Voltage (MLV) and Incandescent TRIAC (leading edge) dimmers. Trusted brands like Lutron and Leviton, prevalent in both residential and commercial settings, are compatible with our drivers, ensuring broad availability and ease of integration.

**Note:** Compatibility list may change without prior notice.

DIMMER COMPATIBILITY LIST				
DIMMER TYPE - LISTED	TRE24L96DC	TRE24L40DC	TRE12L60DC	TRE12L20DC
Lutron Caseta, Wireless PD-6WCL (MLV)	Dims to 0%	Dims to 0%	Dims to 0%	Dims to 0%
Lutron Maestro, Wireless MRF-2-6CL (MLV)	Dims to 1%	Dims to 1%	Dims to 1%	Dims to 1%
Lutron Radio RA2 RRD-6ND (MLV)	Dims to 0%	Dims to 0%	Dims to 0%	Dims to 0%
Lutron Maestro MA-600 (MLV)	Dims to 0%	Dims to 0%	Dims to 0%	Dims to 0%
Leviton Decora Smart DW6HD (MLV)	Dims to 0%	Dims to 0%	Dims to 0%	Dims to 0%
Lutron Nova T NTLV-600 (MLV)	Dims to 1%	Dims to 1%	Dims to 1%	Dims to 1%
Lutron Diva DVLV-600P (MLV)	Dims to 0%	Dims to 0%	Dims to 0%	Dims to 0%
Lutron Diva DVLV-103P (MLV)	Dims to 0%	Dims to 0%	Dims to 0%	Dims to 0%
Lutron Caseta, Wireless PD-10NXD	Dims to 0%	Dims to 0%	Dims to 0%	Dims to 0%
Lutron Maestro MA-PRO (MLV Mode)	Dims to 0%	Dims to 0%	Dims to 0%	Dims to 0%
Lutron Radio RA2 RRD-PRO (MLV Mode)	Dims to 1%	Dims to 1%	Dims to 1%	Dims to 1%
Lutron Caseta, Wireless PD-5NE (MLV Mode)	Dims to 0%	Dims to 0%	Dims to 0%	Dims to 0%
Lutron Caseta , Smart Home Plug-in PD-3PCL	Dims to 0%	Dims to 0%	Dims to 0%	Dims to 0%
Lutron Maestro MACL-153P	Dims to 0%	Dims to 0%	Dims to 0%	Dims to 0%
Lutron Maestro MSC-1000M	Dims to 0%	Dims to 0%	Dims to 0%	Dims to 0%
Lutron Toggle TGCL-153P	Dims to 0%	Dims to 0%	Dims to 0%	Dims to 0%
Lutron Sunnata Touch STCL-153P	Dims to 0%	Dims to 0%	Dims to 0%	Dims to 0%
Leviton Decora Smart DW1KD-1BZ	Dims to 0%	Dims to 0%	Dims to 0%	Dims to 0%
Leviton Decora Digital DDMX1-BLZ	Dims to 1%	Dims to 1%	Dims to 1%	Dims to 1%
Leviton Decora Slide DSM10	Dims to 1%	Dims to 1%	Dims to 1%	Dims to 1%
Leviton Decora Slide DSL06-1LZ	Dims to 0%	Dims to 0%	Dims to 0%	Dims to 0%
GE Z-Wave Plus ZW3005	Dims to 0%	Dims to 0%	Dims to 0%	Dims to 0%
WeMo WiFi F7C059	Dims to 0%	Dims to 0%	Dims to 0%	Dims to 0%
TP-Link Kasa Smart HS220P3	Dims to 0%	Dims to 0%	Dims to 0%	Dims to 0%
Leviton Lumina RF DL1KD-1BZ (MLV)	Dims to 1%	Dims to 1%	Dims to 1%	Dims to 1%

# LED Drivers

An LED driver is a specialized electrical device that manages power for an LED or groups of LEDs. Unlike standard power supplies, an LED driver adapts to the LED's changing requirements, ensuring it receives a consistent power supply as its electrical characteristics vary with temperature.

INDOOR/OUTDOOR NON-DIMMABLE DRIVERS	
<b>LEDDR-12-60W</b>	60W 12V DC, 5A Class 2 LED Driver, outdoor rated
<b>LEDDR-24-120W</b>	LED Driver, 24VDC, 120W, Class 5A, 60W, 2 circuit at 60W each

INDOOR/OUTDOOR DIMMABLE DRIVERS	
<b>TRE12L20DC</b>	Electronic LED Driver 20W, 12V DC, IP rated, dimmable
<b>TRE12L60DC</b>	Electronic LED Driver 60W, 12V DC, IP rated, dimmable
<b>TRE24L40DC</b>	Electronic LED Driver 40W, 24V DC, IP67 rated , dimmable
<b>TRE24L96DC</b>	Electronic LED Driver 96W, 24V DC, IP67 rated , dimmable
<b>E-KO-SR</b>	Wet Location Strain Relief for E Series Drivers, PG7, clamping range dia. 3-6.5mm



LEDDR-12-60W



LEDDR-24-120W



TRE12L20DC  
TRE12L60DC



TRE24L40DC  
TRE24L96DC



E-KO-SR

# LED Drivers Selector Chart

Neon Flex					Strip Series†					Globe Light					Wedge Light									
<b>INDOOR/OUTDOOR NON-DIMMABLE DRIVERS</b>																								
LEDDR-12-60W 12V, 60W, hardwire, outdoor, Max. 60W					-					-					-					Max. 200 Globes				
LEDDR-24-120W 24V, 120W, hardwire, outdoor, Max. 120W					Max 40' (12.1m) per single tap, Max 48' (14.6m) combined two secondary taps					Max. recommended load 90W or 20' (6.1m) per single tap, 120W or 27' (8.53m) combined two secondary taps. CCT series: 16' (4.88m) per single tap, 20'(6.1m) combined two secondary taps					Max. 180 Globes per single tap, max. 120 combined two secondary taps					-				
<b>INDOOR/OUTDOOR DIMMABLE DRIVERS</b>																								
TRE12L20DC†† 12V, 20W, hardwire, outdoor, dimmable, Max. 18W, Min. 10W					-					-					-					Max. 80 Globes				
TRE12L60DC†† 12V, 60W, hardwire, outdoor, dimmable, Max. 54W, Min. 30W					-					-					-					Max. 200 Globes				
TRE24L40DC†† 24V, 40W, hardwire, outdoor, dimmable, Max. 36W, Min. 20W					Max 14.5' (4.4m) Min 8 watts, 3.3' (1m) LED Neon Flex					LED Strip Series: Max. recommended load 36W or 8' (2.44m), Min. 8W or 2' (.61m)					Max. 80 Globes					-				
TRE24L96DC†† 24V, 100W, hardwire, outdoor, dimmable, Max. 90W, Min. 50W					Max 40'(12.1m) Min 8 watts, 3.3' (1m) LED Neon Flex					LED Strip Series: Max. recommended load 90W or 20' (6.1m), Min. 8W or 2' (.61m)					Max. 180 Globes					-				

Hard Strip					eStrip					Disc Light					MiniDisc Light									
<b>INDOOR/OUTDOOR NON-DIMMABLE DRIVERS</b>																								
LEDDR-12-60W 12V, 60W, hardwire, outdoor, Max. 60W					-					-					Max. 18 LEDD					Max. 200 LEDMD				
LEDDR-24-120W 24V, 120W, hardwire, outdoor, Max. 120W					-					-					-					-				
										Max. 90' (27.43m) per single secondary tap, max. 120' (36.58m) combined two secondary taps. RGB eStrip & HP eStrip: 40' (12.1m) per single secondary tap, 50' (15.24m) combined secondary taps														
<b>INDOOR/OUTDOOR DIMMABLE DRIVERS</b>																								
TRE12L20DC†† 12V, 20W, hardwire, outdoor, dimmable, Max. 18W, Min. 10W					-					-					Max. recommended load 18W or 6 LEDD Min. recommended load 8W or 3 LED Disc Lights					Max. 75 LEDMD Min. recommended load 8W or 34 LED MiniDisc Lights				
TRE12L60DC†† 12V, 60W, hardwire, outdoor, dimmable, Max. 54W, Min. 30W					-					-					Max. recommended load 54W or 18 LEDD Min. recommended load 8W or 3 LED Disc Lights					Max. 200 LEDMD Min. recommended load 8W or 34 LED MiniDisc Lights				
TRE24L40DC†† 24V, 40W, hardwire, outdoor, dimmable, Max. 36W, Min. 20W					Max. recommended load 36W, Min. 8W LED Hard Strip					LED eStrip: Max. 37.5' (11.43m), Min. 8W, 9' LED eStrip (2.44m). High Power: Max. 18' (5.49m), Min. 4' (1.2m)					-					-				
TRE24L96DC†† 24V, 100W, hardwire, outdoor, dimmable, Max. 90W, Min. 50W					Max. recommended load 90W, min. 8W LED Hard Strip					LED eSTRIP: Max. 90' (27.4m), Min. 8W, 9' LED eStrip (2.44m). High Power: Max. 40' (12.19m), Min. 4' (1.2m)					-					-				

† Note: Above maximum and minimum lengths are for Standard Tape. You may double these when using LP, Low Power Tape.  
 †† TRE drivers require E-KO-SR for outdoor applications  
 \* Please refer to catalogue for # of LEDs per fixture.

# LED Controllers List

The selection includes a PIR Motion Sensor for 12/24V DC systems, facilitating energy-efficient, motion-activated lighting. The lineup features WiFi Signal Amplifiers and Controllers, compatible with RGB, RGBW, and CCT setups, ensuring robust signal strength and versatile light management. Additional offerings include a remote control for the WiFi system, an outdoor-rated RGB signal amplifier, and an RF mini controller with an extension cable for LED Hard Strips. For tactile control, there is an RF Touch Control for RGBW lighting, alongside a Signal Amplifier designed for RGB-W systems, catering to both indoor and outdoor lighting scenarios.

Product	Description
<b>SENSORS</b>	
LV-SPIR-1CH-LV	PIR Motion Sensor, 1 Channel, 12/24V DC
<b>CONTROLLERS &amp; AMPLIFIERS</b>	
LT-WIFI-AMP	WiFi Signal Amplifier for RGB, RGBW, CCT
LT-WIFI-CTRL	WiFi Controller for RGB, RGBW, CCT
LT-WIFI-RM	Remote for LT-WIFI-CTRL
LV-ZJFFS-3CH-6INW	Signal Amplifier for RGB 12/24V DC, 3 channel, outdoor
LV-RF103	Wireless RF mini RGB controller 24V, 96W
LV-RF103-HW	Wireless RF Mini RGB controller 24VDC, 96W, Hard Wire
LV-RF103-EXSS	6" Tape Extension connector for LV-RF103 controller
LT-11S-RF	RF Touch Control controller for RGBW
LT-490A	Signal Amplifier for RGB-W 12/24V DC



LV-SPIR-1CH-LV



LT-WIFI-AMP



LT-WIFI-CTRL



LT-WIFI-RM



LV-ZJFFS-3CH-6INW



LV-RF103



LT-11S-RF



LT-490A

# Transformers - Magnetic



ETL listed indoor and outdoor.



**TR-12-150**  
10" x 3.1" x 3"  
1 circuit at 150 watts for 12V AC



**TR-12-240**  
10" x 4.25" x 3.6"  
1 circuit at 240 watts for 12V AC



**TR-12-300 or TR-24-300**  
10" x 4.25" x 3.6"  
2 circuits at 150 watts each for 12V AC



**TR-24-480**  
11.1" x 4.75" x 4.25"  
1 circuit at 480 watts for 24V AC



**TR-24-600**  
11.1" x 4.75" x 4.25"  
2 circuits at 300 watts each for 24V AC



**TR-24-960**  
12.5" x 7.0" x 4.75"  
2 circuits at 480 watts each for 24V AC



# Transformers - Electronic

UL listed as a component ("RU" Marking).

\*NOTE: Check your fixture listing for acceptability. All connections must be made per fixture listing and NEC. 120V AC input/11.6V AC output.



**TE-12-75**  
12 Volt, 75 watt Electronic Transformer



**TECLT-12-60**  
6.5" x 1.5" x 1.5"  
Class 2, 1 circuit at 60 watts, for 11.7V AC

# Appendix

	Sub-Category	Lighting Solution	Technical Details	Page
<b>Linear Lighting</b>	<b>Tape Light</b>	High Density, High Power Indoor	24V; 5.8W/FT; 3000/4000/6500K; 16' MAX RUN; OUTPUT: 450-514 LM/FT	5
		High Density, Low Power Indoor	24V; 2.9W/FT; 3000/4000/6500K; 31' MAX RUN; OUTPUT: 225-257 LM/FT	7
		CCT Indoor	24V; 5.8W/FT; 2500-7000K. 16' MAX RUN; OUTPUT: 261-383 LM/FT.	9
		COB Indoor	24V; 4.2W/FT; 2700/3000/3500/4000/6500K; 20' MAX RUN; OUTPUT: 315-374 LM/FT	11
		Dim to Warm	24V; 5.5W/FT; 1800-3000K; 16' MAX RUN; OUTPUT: 449LM/FT	13
		High Efficacy Indoor	24V; 5.1W/FT; 2700/3000/3500/4000/6500K; 16' MAX RUN OUTPUT: 508-586 LM/FT	15
		High Power Indoor	24V; 4.3W/FT; 2700/3000/3500/4000/6500K; 20' MAX RUN OUTPUT: 280-325 LM/FT	17
		High Power Outdoor	24V; 4.3W/FT; 2700/3000/3500/4000/6500K; 20' MAX RUN OUTPUT: 280-325 LM/FT	19
		High Power, RGB Indoor	24V; 4.3W/FT; RGB; 20' MAX RUN	21
		High Power, RGB Outdoor	24V; 4.3W/FT; RGB; 20' MAX RUN	23
		High Power, RGBW Indoor	24V; 4.3W/FT; RGB + 3000/4000/6500K; 20' MAX RUN	25
		Low Power Indoor	24V; 2.2W/FT; 2700/3000/3500/4000/6500K; 40' MAX RUN; OUTPUT: 143-165 LM/FT	27
		Low Power Outdoor	24V; 2.2W/FT; 2700/3000/3500/4000/6500K; 40' MAX RUN; OUTPUT: 143-165 LM/FT	29
		Low Power, RGB Indoor	24V; 2.2W/FT; RGB; 40' MAX RUN	31
	Low Power, RGB Outdoor	24V; 2.2W/FT; RGB; 40' MAX RUN	33	
	Extrusions	-	35	
	<b>120V eStrip</b>	120V eStrip	120V AC; 3.7W/FT; 3000/4000/6000K; 164' MAX RUN; OUTPUT: 366 LM/FT	37
	<b>eStrip</b>	Low Power eStrip	24V; 0.96W/FT; AMBER, RED, PURE GREEN; 3000/5800K. 90'MAX RUN; OUTPUT: 55-61 LM/FT	39
		High Power eStrip	24V; 2.2W/FT; 3000/5800K; 40' MAX RUN; OUTPUT: 137-155 LM/FT	41
		RGB eStrip	24V; 2.2W/FT; RGB; 40' MAX RUN	43
<b>Neon Flex</b>	Neon Flex	24V; 2.44W/FT; RED, GREEN, BLUE, AMBER; RGB; 3000/4000/6000K; 40' MAX RUN; OUTPUT: 61LM/FT	45	
<b>String Lights</b>	Globe Light	24V; .5W/Ft; 2700/6000K; RED, GREEN, BLUE, AMBER; 150' MAX RUN; OUTPUT: 50 LM/FIXTURE	47	
	Wedge Light	12V; .25W/FT; AMBER; RED; GREEN; 2700/6000K. 100' MAX RUN; OUTPUT: 55-61 LM/FT	49	
<b>Wall Washer</b>	24V Wall Washer	24V; 5.8W/FT; 2700/3000/4000K; 16' MAX RUN; OUTPUT: 100-110 LM/FT	51	
	Wall Washer 4' Enclosed	24V; 23.2W; 2700/3000/4000K; OUTPUT: 400-440LM	53	

	Sub-Category	Lighting Solution	Technical Details	Page
<b>Under Cabinet Lighting</b>	-	5CCT LED Task Bar	120V AC. 3.5W-20W; 2700/3000/3500/4000/5000K; OUTPUT: 290-1892LM	56
		Gen II LED Hard Strip	24V; 4W-16W; 3000/4200K; OUTPUT: 380-1150 LM/FIXTURE	58
		Gen II 3-Colour Change LED Task Star	120V AC; 5W-25W; 3000/4000/5000K; OUTPUT: 310-1500LM	60
		LED Task Star Pro	120V AC; 3W-20W; 2700/3300/4000K; OUTPUT: 150-1000LM	62
		LED Edgelit Puck Lights	24V; 4W; 3000K; OUTPUT: 200LM	64
<b>Flood and Spot Lights</b>	-	Uplight (Wattage Adjustable)	12V; 0-12W; 3000K; OUTPUT: 900LM	67
		Uplight (RGBW)	12V; 0-8W; RGBW; OUTPUT: 500LM	69
		12V Mini Flood Light	12V; 1-5W; 3000K; OUTPUT: 400LM	71
		120V Mini Flood Light (CCT)	120V AC; 15-50W; 3000/4000/5000K; OUTPUT: 1750-7000LM	73
<b>Pathway Lights</b>	-	Modern Pathway Light	12V; 1-3W; 3000K; OUTPUT: 80-240LM	75
		Round Tea-Hat Pathway Light	12V; 1-3W; 3000K; OUTPUT: 80-240LM	77
		HD Classic Pathway Light	12V; 5W; 3000K; OUTPUT: 400LM	79
		Commercial Bollards	120V-347V AC; 8W-25W; 3000/4000/5000K; OUTPUT: 1000-3125LM	81
<b>Landscape Lighting</b>	<b>Wall and Deck Lights</b>	Surface Mount Deck Light	12V; 1-3W; 3000K; OUTPUT: 60-180LM	83
		Outdoor Wall Sconce	120V-240V AC; 15W; 3000/4000K; OUTPUT: 1300LM	85
		Brick Star (GEN II)	120V AC; 5.2W; 3000K; OUTPUT: 468LM	87
		Step Star (GEN II)	120V AC; 5.2W; 3000K; OUTPUT: 468LM	89
		Switch Star	120V AC; 1.4W; 2700K; OUTPUT: 80LM	91
		<b>In Ground Lights</b>	-	Disc Light
Mini Disc Marker Light	12V; 0.24W; 2900/5400K; BLUE, GREEN, AMBER, RED			95
Mini Disc Light (Scoop)	12V; 0.24W; 2900/5400K; BLUE, GREEN, AMBER, RED			97
Disc Light Dome	12V; 3W; 2700/5500K; OUTPUT: 95-98LM			99
<b>Transformers &amp; Accessories</b>	-	Well Light	12V; 6W; 3000K; OUTPUT: 580LM	101
		100W Transformer	120V; 100W MAX; 12V	103
		300W Transformer	120V; 300W MAX; 12-15V; 13AMP BREAKER ON PRIMARY	105

# Appendix (Continued)

	Sub-Category	Lighting Solution	Technical Details	Page
Down Lighting	Thin Lines	5CCT LED Thin Line Down Light (Round)	120V AC; 6-20W; 2700/3000/3500/4000/5000K; OUTPUT: 420-1944LM	108
		5CCT LED Thin Line Down Light (Square)	120V AC; 9/12W; 2700/3000/3500/4000/5000K; OUTPUT: 630/840LM	110
	Regressed	Regressed Down Light (CCT)	120V AC; 9-12W; 2700/3000/4000K; OUTPUT: 630-800LM	112
	Gimbal	5CCT LED Gimbal Down Light	120V AC; 8/14/18W; 2700/3000/3500/4000/5000K; OUTPUT: 650/1000/1200LM	114
	Surface Mount / Decorative	Surface Mount Down Lights (Round)	120V AC; 11-22W; 3000/4000K; OUTPUT: 880-1850LM	116
		Surface Mount Down Lights (Square)	120V AC; 11-22W; 3000/4000K; OUTPUT: 880-1850LM	118
		Ceiling Lights	120V AC; 25W; 3000K; OUTPUT: 1875LM	120
		Wall Sconce	120V AC; 15W; 3000K; OUTPUT: 1500LM	122
	T-Edge Lights	T-LED Edge Light (5CCT)	100-277V AC; 20-60W; 3500/4000/5000K; OUTPUT: 2200-6600LM	124
	Fire Rated	5CCT Fire Rated Thin Line	120V AC; 12-15W; 2700/3000/3500/4000/5000K; OUTPUT: 800-1100LM	126
Industrial Lighting	-	Tri-Proof Lights	100-277V AC; 40W; 4000K; OUTPUT: 4400LM	129
		100W LED Work Light	100-277V AC; 100W; 5000K; OUTPUT: 12500LM	131
		60W LED Work Light	120V AC; 60W; 5000K; OUTPUT: 7200LM	133
		LED String Work Light	120V AC; 60W; 5000K; OUTPUT: 7500LM	135
Drivers & Controllers	Switchex®			138
	Dimmable Driver/Dimmer Compatibility List			140
	LED Drivers			141
	LED Drivers Selector Chart			142
	LED Controllers List			144
Transformers	Magnetic & Electronic			146
Appendix	-			148
Logos/Icons	-			151

# Logos/Icons



Intertek's ETL Certified



Energy Star Certified

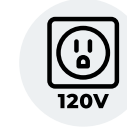

120 Volts of AC Power



cULus Certified



DLC Certified



CCT



Wet Location Listed



RGB



Dimmable



Wattage Adjustable

# WARRANTY

NATIONAL SPECIALTY LIGHTING (NSL) warrants this lighting system to be free from defects in material and/or workmanship, under normal use and service, for a period of TWO to SIX YEARS (see specifics on product specifications) from the date of original purchase.

In the event of a defect in material or workmanship during the warranty period, NSL will repair or replace (at its option) your Lighting System under the conditions of warranty. NSL will do this at its expense for the cost of materials but not for shipping. THIS REMEDY IS THE SOLE AND EXCLUSIVE REMEDY FOR ANY AND ALL CLAIMS RELATING TO ANY BREACH OF WARRANTY BY NSL.

## LIMITATIONS, EXCLUSIONS AND OTHER RIGHTS

- A. Except as provided herein, NSL makes no other warranties express or implied, including but not limited to the implied warranties or merchantability or fitness for a particular purpose, and all such warranties are expressly disclaimed.
- B. In no event shall NSL be liable for indirect, incidental or consequential damages, even if NSL has been advised of the possibility of such damage. This disclaimer applies during and after warranty period.
- C. NSL is not responsible for malfunctions in and/or damage to Lighting Systems where a sale is specifically made without warranty. In such an event the disclaimers of warrant and liability, set forth above, shall continue to apply.
- D. This warranty covers normal consumer use and does not cover damage which occurs during shipment or failure which results from alteration, accident, theft, misuse, abuse, abnormal use, negligent installation, improper maintenance or where adequate care has not been taken to prevent ice or snow damage to the lighting system.
- E. Specifically, when installing mini disc lights in harsh environments such as limestone, salted areas, coastal environments etc. Please use the stainless steel version to avoid the risk of corrosion to body of fixture and voiding warranty.

If you discover a defect or malfunction during the period to which this warranty applies, call or email Magic Lite 2013 Ltd. for information or to receive warranty service.

**Note: You must contact our office for a RETURN GOODS AUTHORIZATION number before returning product. After inspection it will be determined whether a credit is due.**



**Free Shipping**

Once a customer has reached a cumulative purchase level of \$3,000.00, they are entitled to free normal UPS ground freight charges within the 48 contiguous states on every order\* (residential deliveries excluded) \*Minimum \$100.00 order to qualify for free freight. With our prompt delivery pledge National Specialty Lighting offers same day shipping on all non-custom orders placed before 12:00pm Eastern Time.



**365 Day Return Policy**

The 365-day return policy allows customers to take advantage of new National Specialty Lighting products, define new markets and help to build their business. A National Specialty Lighting Stocking Distributor may return any current stock item within 12 months of purchase date for a restocking fee of 50%. The restocking fee will be waived if the distributor places a stock order of equal value or greater than the value of the items being returned. No special catches or exceptions. Items are sent back to National Specialty Lighting prepaid in the original packaging, and merchandise is in resalable condition.



**No Minimum Orders**

National Specialty Lighting does not have a minimum order requirement, and never will. Some companies require you to purchase large quantities of products or meet a specific spending target. Companies use the excuse that it's the cost to process the order. National Specialty Lighting orders are filled regardless of how large or small they are! If you want to purchase just one item to finish a project, no problem, your order is always treated as a priority.



**Tracking Orders**

Tracking your order has never been easier; simply provide us with an email address and you will automatically be notified when your order has been shipped. All orders are shipped though UPS. Send an email to [nslsales@nslusa.com](mailto:nslsales@nslusa.com).