

Well Light

Illuminate columns, fences, and trees discreetly with this well light. Designed for flush installation, it features a robust die-cast aluminum housing and a powerful integrated 6-watt LED. Waterproof and backed by a 15-year warranty.



FEATURES

- Low-profile design for discreet lighting
- Robust die-cast aluminum construction
- Silicon filled wirenuts
- IP67 rated
- Wet location listed
- Powerful 6-watt integrated LED
- Weatherproof for outdoor durability
- Bright 580-lumen output
- Stylish black finish for modern appeal
- Effortless installation with included sleeve
- Backed by 15 years warranty

APPLICATIONS

- Column and pillar illumination
- Pathway and boundary lighting
- Tree canopy highlighting
- Garden and seating area visibility
- Water feature enhancement
- Step and stair safety lighting



SPECIFICATIONS

Product Code	IG-01-12V-36D-BLK		IG-01-12V-60D-BLK	
Electrical	Input Voltage	12/24V AC/DC		
	Power Consumption	6W		
Specs	Colour Temperature	3000K		
	CRI	90+		
	Lumen Output	580LM		
	Efficacy (LM/W)	97		
	Dimmable	No		
	IP Rating	IP67		
	Beam Angle	36°	60°	
	LED	Type	SMD2835	
Life Span		50,000 Hours		
Design	Dimensions (Inches)	3.03 x 4.02"		
	Dimensions (Millimeters)	76.9 x 102 mm		
	Finish	Black		
	Material	Die-cast Aluminum		
	Cable	Copper		
	Operating Temperature	-20 to 40°C		
	Approved Location	Outdoor		
	Mounting	In-ground		
Warranty	15 years			
Approvals	cETLus			

DIAGRAM

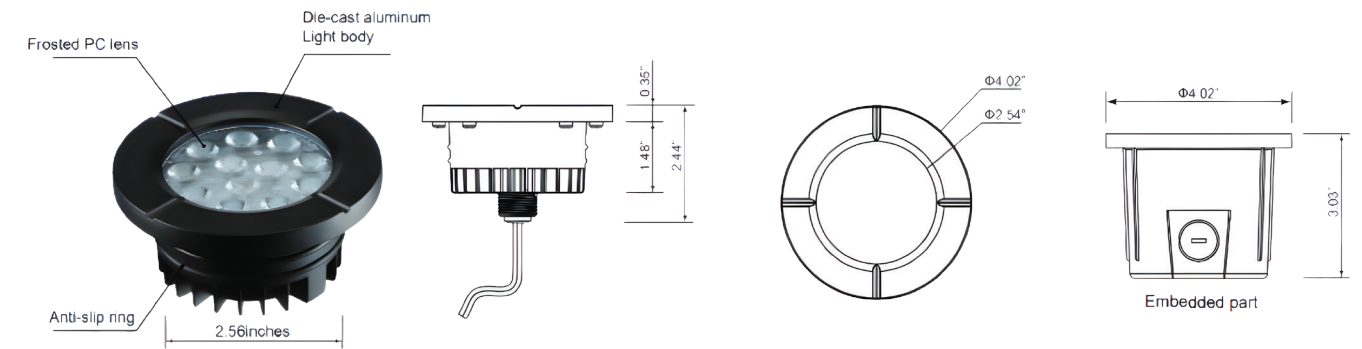

ACCESSORIES



ACC-12G-2C-BUR

Landscape burial wire, 12G, 2C - 500ft spool

ACC-12G-2C-BUR-XX

Landscape burial wire, 12G, 2C - custom cuts

NOTE: A transformer is required. See page 106 to 109.