

LV-ALP007

Surface mount aluminum extrusion and frosted PC cover

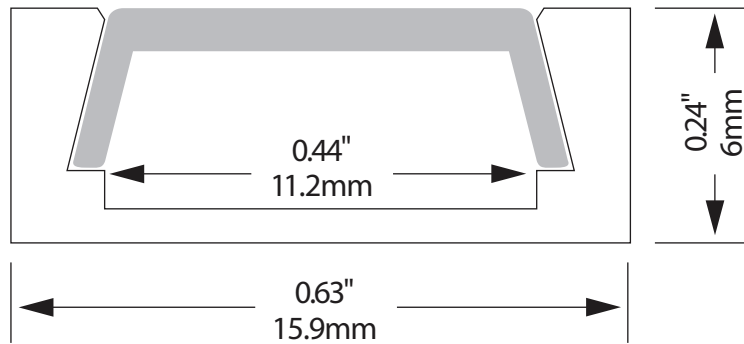

Product Codes

LV-ALP2207
LV-ALP2207-2M

End Caps

LV-ALP007-EC (2/bag)
LV-ALP007-EC-WF (2/bag)

Mounting Clips

LV-ALP007-MC (6/bag)

***Note:** Available in 1m (39") and 2m (78") lengths

4		
3		
2		
1		



Project:

Part Number: LV-ALP007

Scale:

Product: LED Strip Series Extrusion

Type:

Date: