

0/1~10V Dimming Controller

This versatile dimming driver provides precise 0-100% brightness control via 0-10V, 1-10V, and 10V PWM signals. It features 2.4GHz wireless technology for smartphone and voice assistant control (gateway required). With long-range, stable signal transmission and auto-transmitting capabilities, it's ideal for seamless integration into various lighting systems, offering reliable performance and easy installation.



FEATURES

- Supports 0-10V, 1-10V, and 10V PWM dimming.
- Links with 2.4G remotes via SET button, up to 30m range.
- Auto-transmits signals for extended control distance.
- Includes DND mode for power conservation.
- Compatible with Tuya Smart app (2.4GHz gateway required).
- Supports Alexa, Google Assistant, and other voice controls (gateway required).

COMPATIBLE FIXTURES

Please refer to the 'LED Controllers List' section on page 161

SPECIFICATIONS		
Product Code		CNTRL-0-10V-DIM
Electrical	Input Voltage	DC12-48V
	Output Current	Max 12A
	Output Power	144-576W
	Output Type	0~10V/1~10V/10VPWM/PUSH Dimming
Specs	Control Signal	2.4GHz RF
	Control Distance	30m
	IP Rating	IP20
	Dimming Range	0.1% - 100%
	Operating Temperature	-10 to 40°C
Dimensions		1.50 x 4.88 x 0.87 inches
		38 x 124 x 22mm
Approvals		RoHS

PRODUCT CODES

CNTRL-0-10V-DIM

DIAGRAM

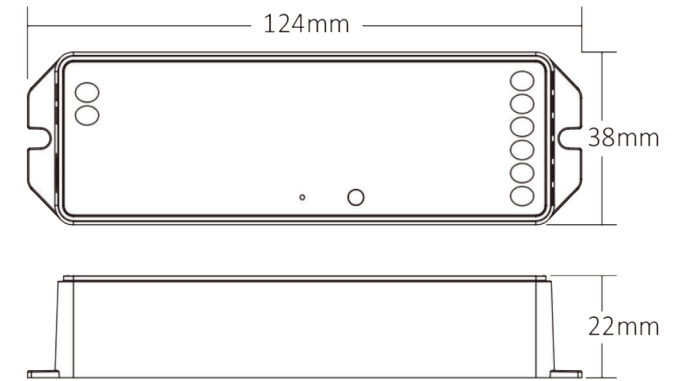

CONNECTION DIAGRAM

